

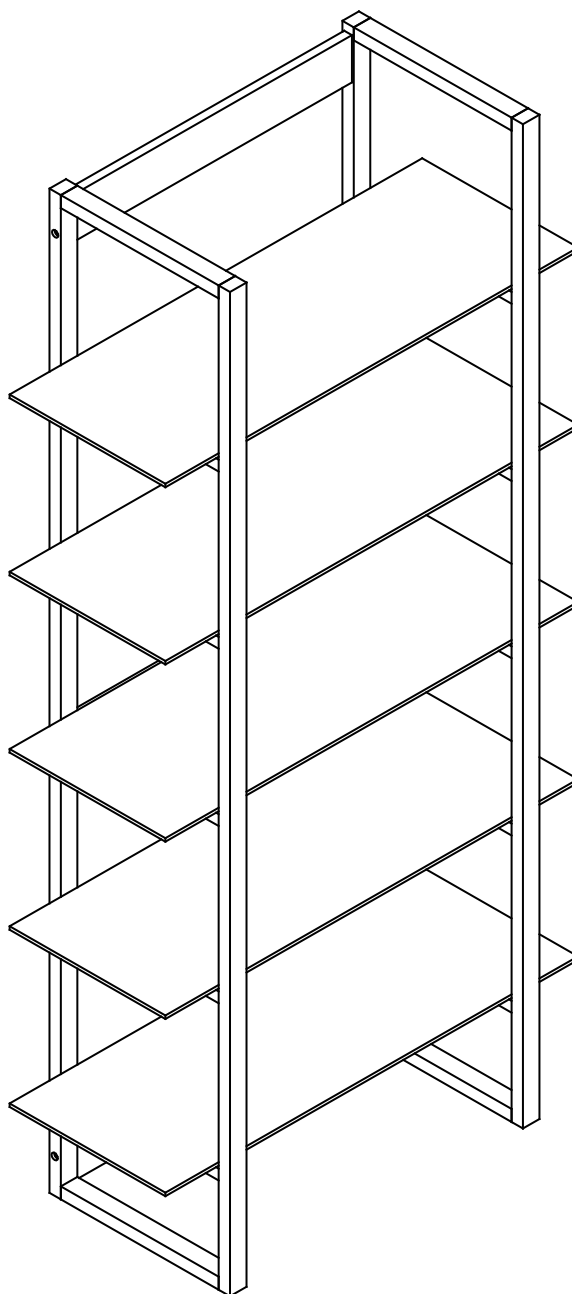

**Fantastic
Furniture**

Version 1.0



Two People

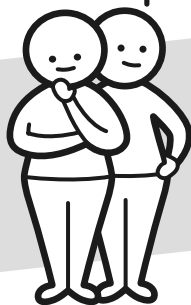

Required

Toto
Bookcase 5 Shelf

fantasticfurniture.com.au

Secure it!

Reduce the risk of furniture tip-over accidents



WARNING: ENSURE THE WALL STRAP IS ATTACHED TO AVOID SERIOUS INJURY OR DEATH.

To avoid any serious or fatal injury, a wall strap has been provided with this product to prevent toppling. We strongly recommend that this product is permanently fixed to the wall or other suitable surface. Fixing devices are not included since different surface materials require different attachments. Please seek professional advice if you are in doubt of what fixing device to use.

Recommended Weight Capacity :10kg/shelf

To reduce the risk of furniture tipover:



- Do not allow children to stand, climb or hang on furniture. It may topple and cause serious injury or death.

- Do not place toys or other child appealing items on top of this furniture, and place heaviest items towards the bottom of the furniture.

- Do not open more than one drawer at the time.



- Anchoring this product to a wall or other suitable surface is recommended. Check anchors regularly.

- Avoid putting a TV on this product.

Wall attachment guide

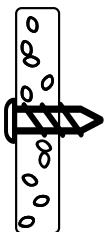

For plasterboard
(without available wood stud)

Securing method:
Self drilling plasterboard anchor.

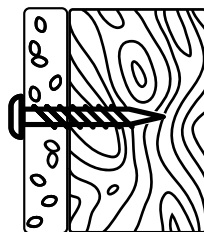

For plasterboard
(with available wood stud)

Securing method:
Screw inserted directly into stud.

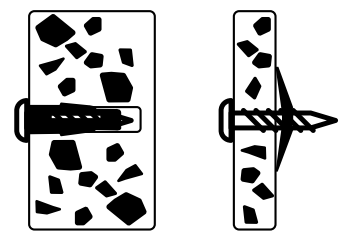

For masonry wall

Securing method:
Solid wall: Plug with screw
Hollow wall: Spring toggle

Please seek professional advice if you are in doubt of what fixing device to use.

Looks like you've found your Fantastic!

We're thrilled you've chosen Fantastic Furniture
to help create a home you'll love!



Fantastic Furniture

Love it? Share it!

Fantastic buy! Share how it looks at home on Instagram for
your chance to win a \$250 Fantastic Furniture Gift Card!

@fantasticfurniture

Assembly Checklist



Read through the instructions carefully before you begin.

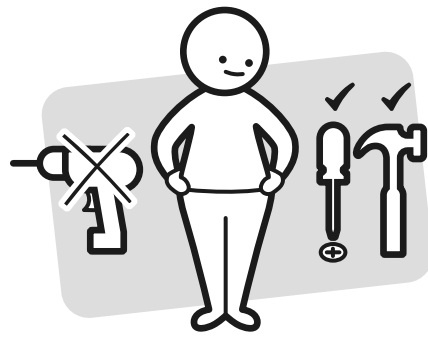

Make sure you have all the required tools. Never use power tools unless instructed.

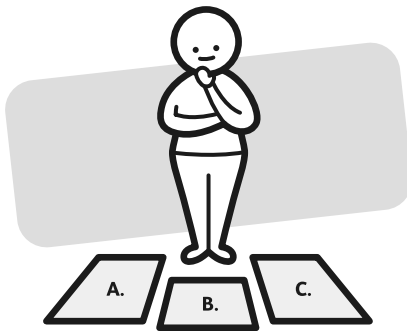

Identify and lay out all of the components before you begin assembly.

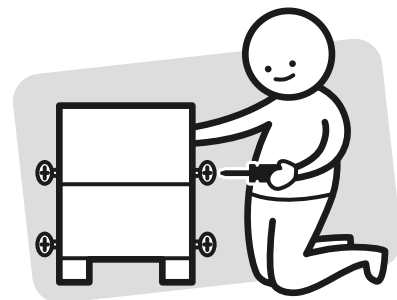

Unless instructed, do not fully tighten screws until the item is fully assembled.

Useful Information

- ! Never use power tools unless specifically instructed. They can damage your components or hardware if used incorrectly.
- ! The most common mistakes made during assembly are using the wrong hardware or getting components back to front.
- ! Always use a soft surface (such as carpet or cardboard) when assembling your product to avoid scratching or damaging the surface of the product.
- ! Bulky items such as wardrobes and bunk beds should be assembled in the room they will be used in as they may not fit through a door once assembled.
- ! Never use any glue until you are certain that the parts belong together.
- ! Periodically check and re-tighten all fasteners. Check the product care label or website for product care instructions.
- ! If you are having any difficulties assembling your product, missing any hardware or components please visit our website Help Centre for further assistance.
- ! Please see page 2 for any safety requirements or weight restrictions.

What you need

to assemble the product



DO NOT USE

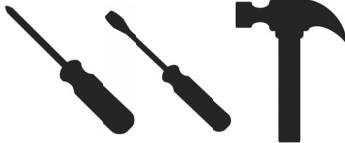

Other tools you need:
Phillips head screwdriver;
Flat head screwdriver;
Hammer

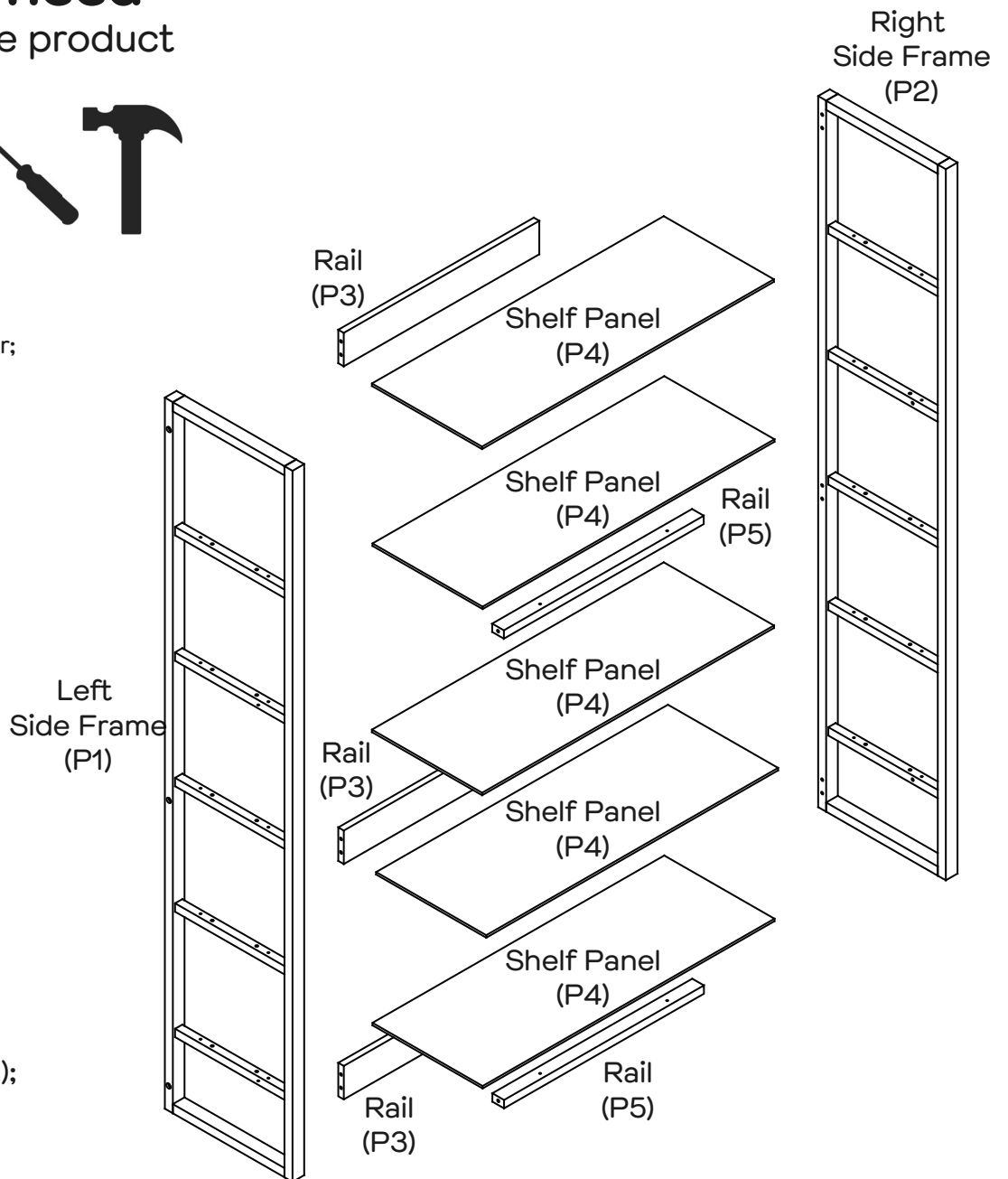



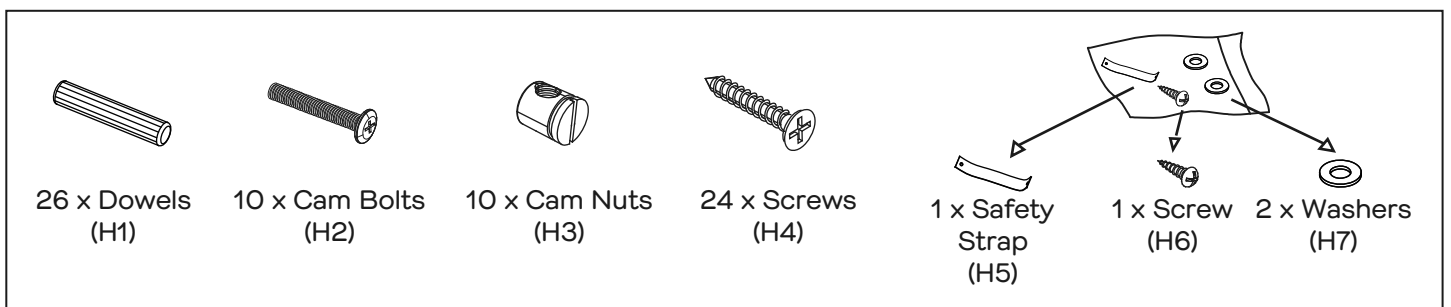

Parts list

Left Side Frame (P1);
Right Side Frame (P2);
3 x Rails (P3);
5 x Shelf Panels (P4);
2 x Rails (P5);

Hardware pack





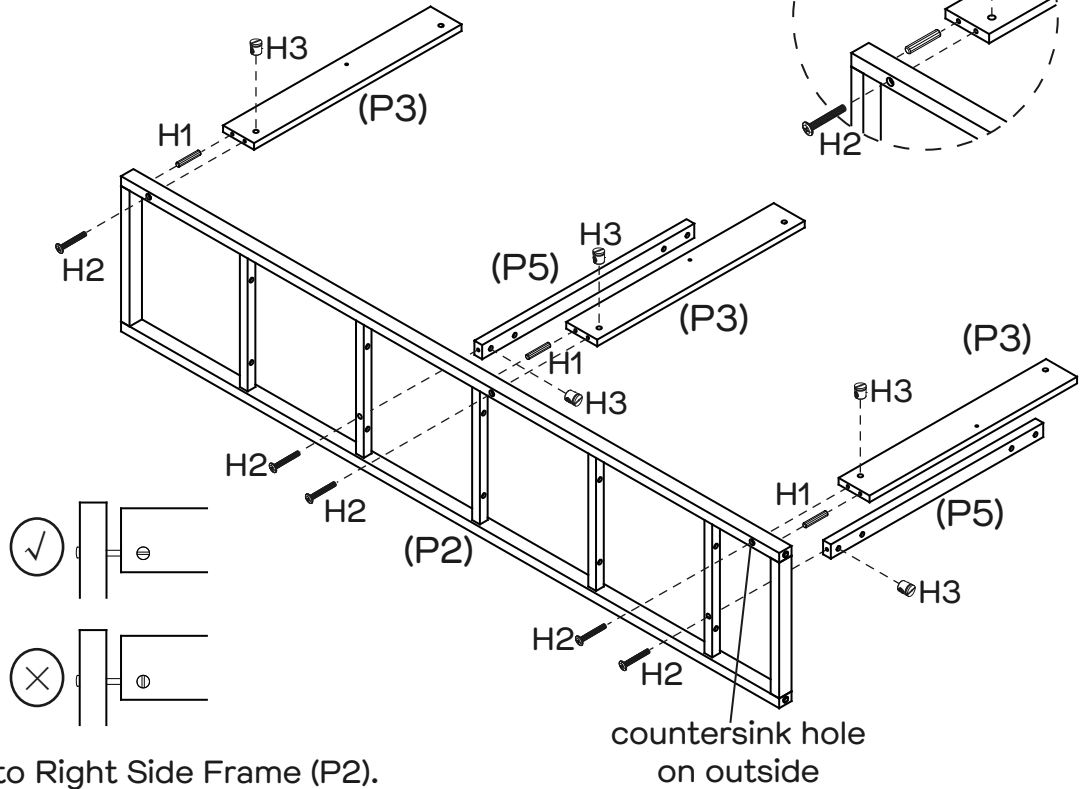

Step 1

You will need	
	
3 x Dowels (H1)	5 x Cam Bolts (H2)
	
5 x Cam Nuts (H3)	Phillips head screwdriver
	
Flat head screwdriver	



Insert 3 x Dowels (H1) into Right Side Frame (P2).
 Push 5 x Cam Bolts (H2) through Right Side Frame (P2) attach with Rails (P3, P5) with 5 x Cam Nuts (H3) using a Flat head screwdriver.
 Tighten with Phillips head screwdriver.

Step 2

You will need	
	
3 x Dowels (H1)	5 x Cam Bolts (H2)
	
5 x Cam Nuts (H3)	Phillips head screwdriver
	
Flat head screwdriver	

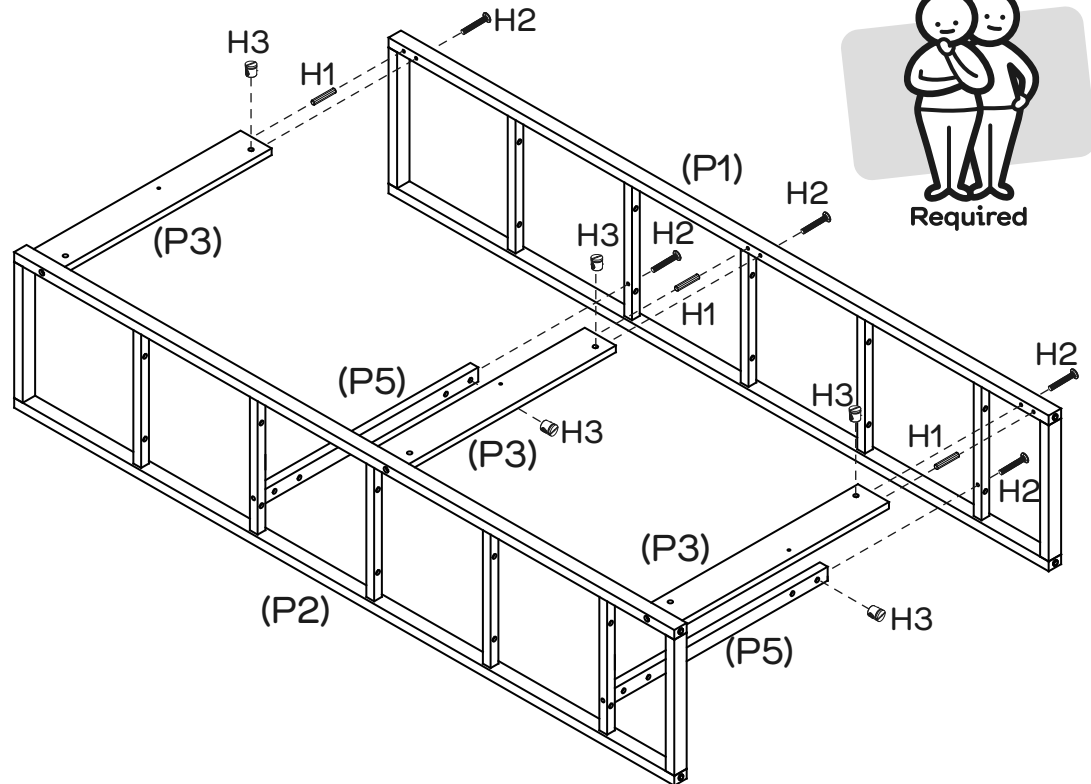

Insert 3 x Dowels (H1) into Left Side Frame (P1).
 Push 5 x Cam Bolts (H2) through Left Side Frame (P1) attach with Rails (P3, P5) with 5 x Cam Nuts (H3) using a Flat head screwdriver.
 Tighten with Phillips head screwdriver.

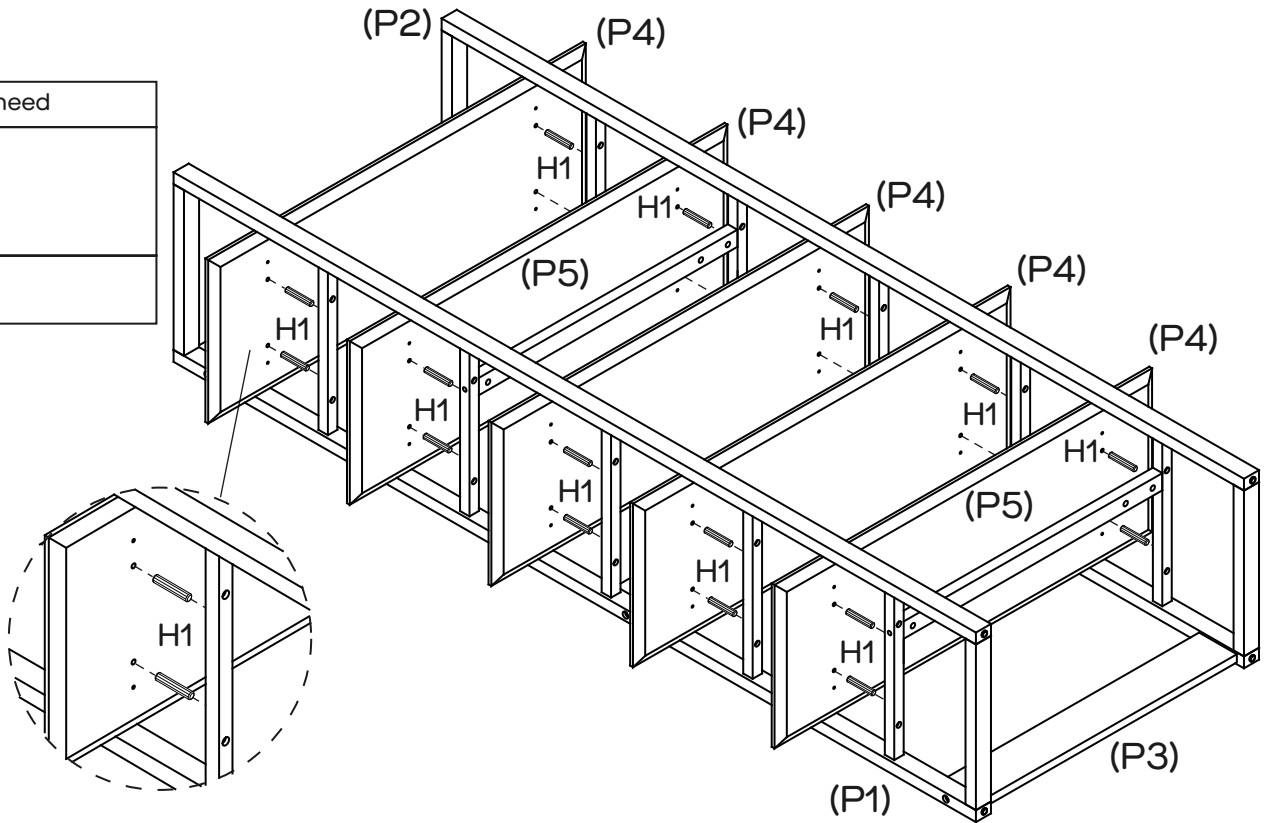

Step 3

You will need	
	
20 x Dowels (H1)	



Insert 20 x Dowels (H1) into Side Frames (P1, P2) and attach with Shelf Panels (P4).



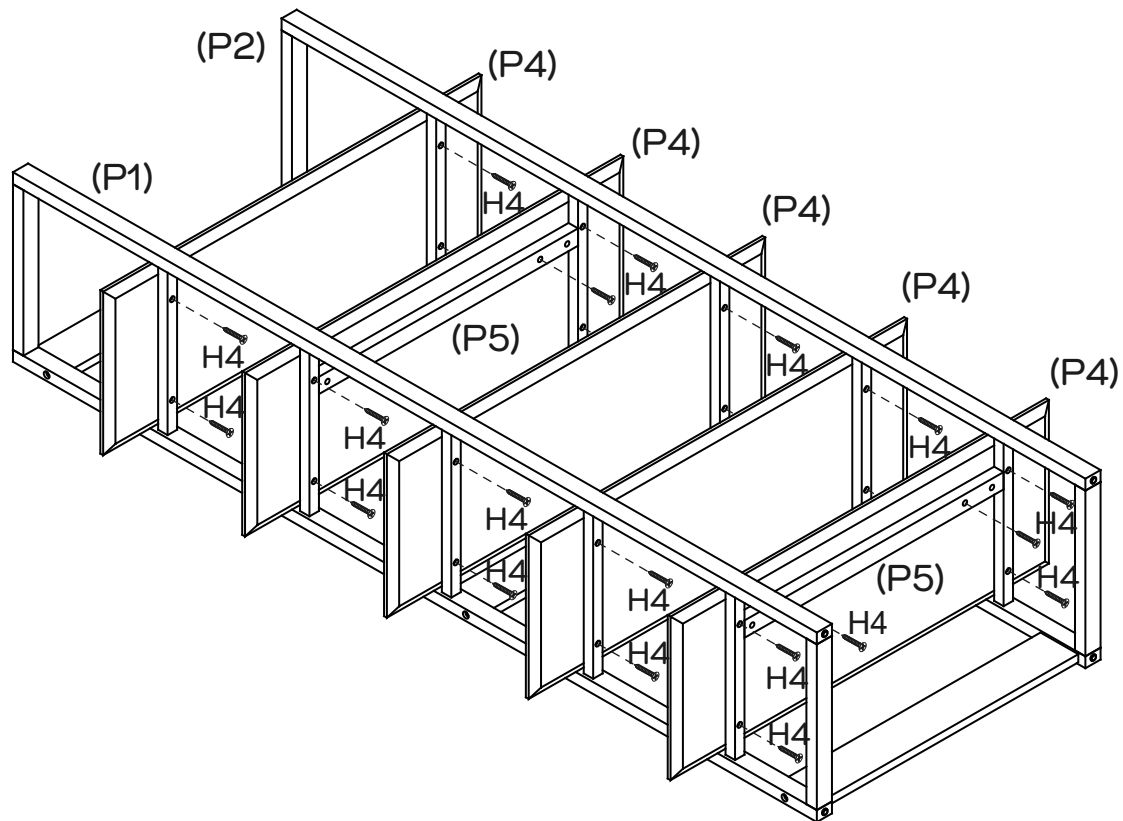

Step 4

You will need	
	
24 x Screws (H4)	Phillips head screwdriver



Attach Shelf Panels (P4) to Side Frames (P1, P2) and Shelf Panels (P4) to Rails (P5) with 24 x Screws (H4) using a Phillips head screwdriver. Tighten with Phillips head screwdriver.

Step 5

You will need	
	
1 x Safety Strap (H5)	1 x Screw (H6)
	
1 x Washer (H7)	Phillips head screwdriver

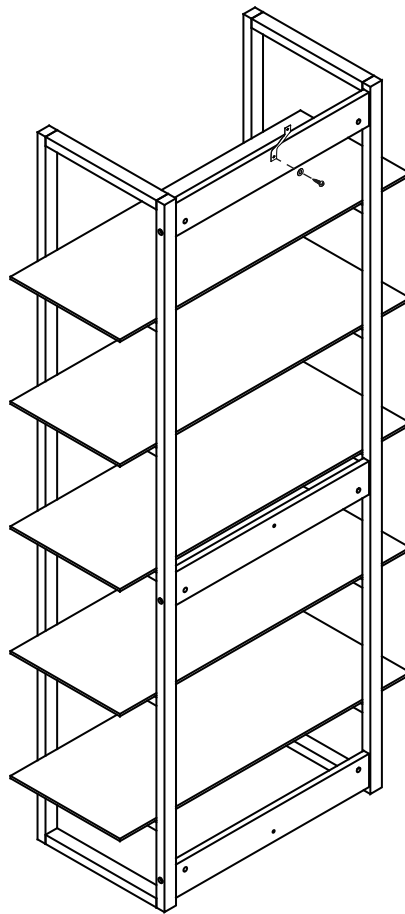

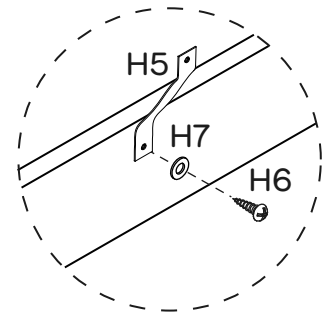

We strongly advise that you use the wall safety strap provided to prevent the unit toppling



Use Screw (H6) and Washer (H7) to connect Safety Strap (H5) on Rail (P3).

Step 6

You will need	
	
1 x Washer (H7)	Phillips head screwdriver
Screw and Wall Plug are not provided. Please use appropriate fixtures for your wall.	

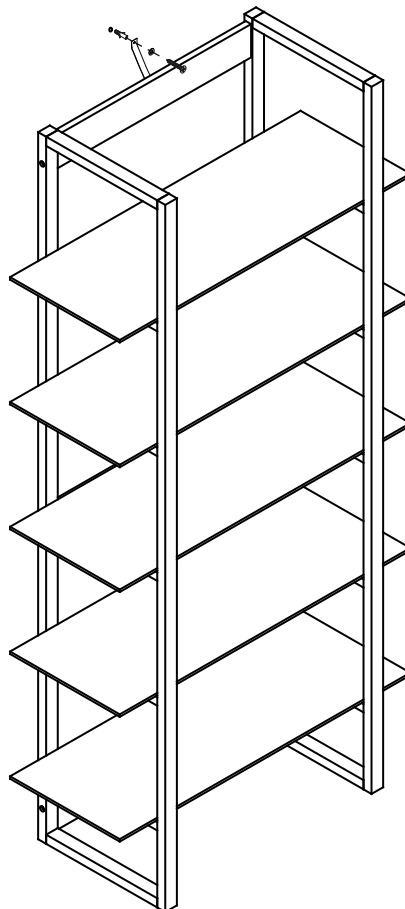

Seek advice from a qualified trades person on how to attach this safety strap to your specific wall.

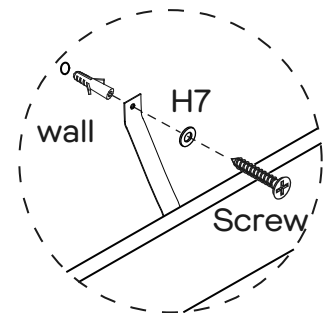

Move the bookcase to the final position. Attach the safety strap to the wall. Make sure it is firmly attached and make sure it is snug fit.

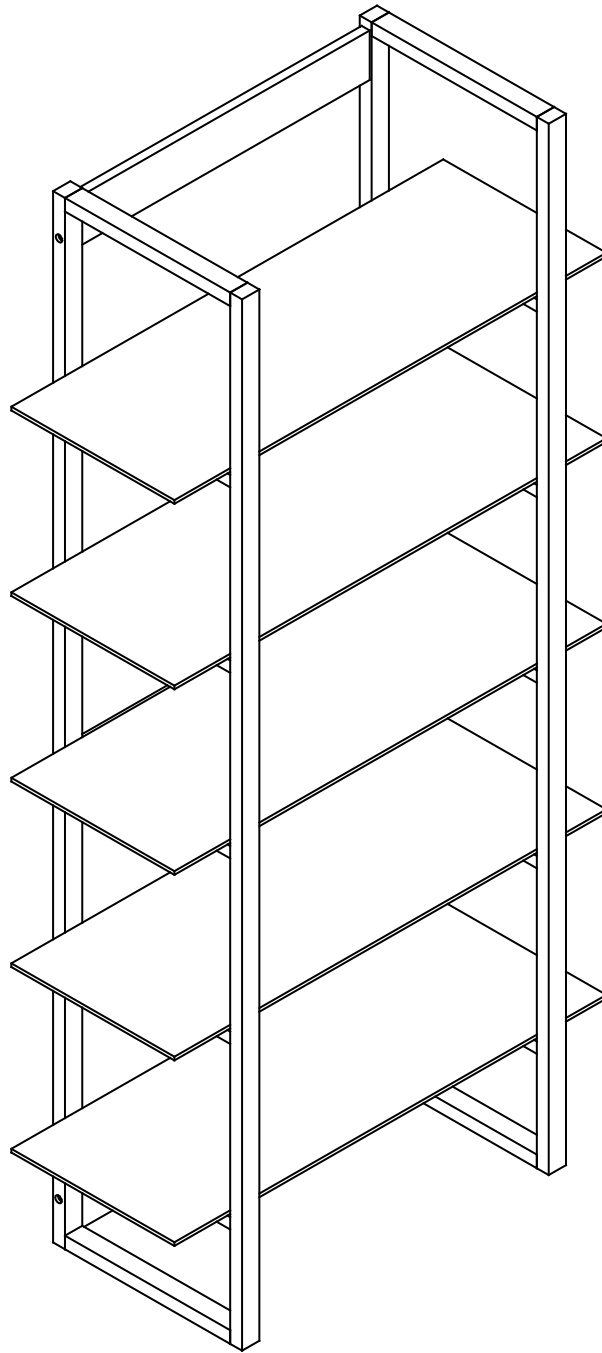

Job Complete!

In the interest of our environment please dispose of all packaging thoughtfully.