

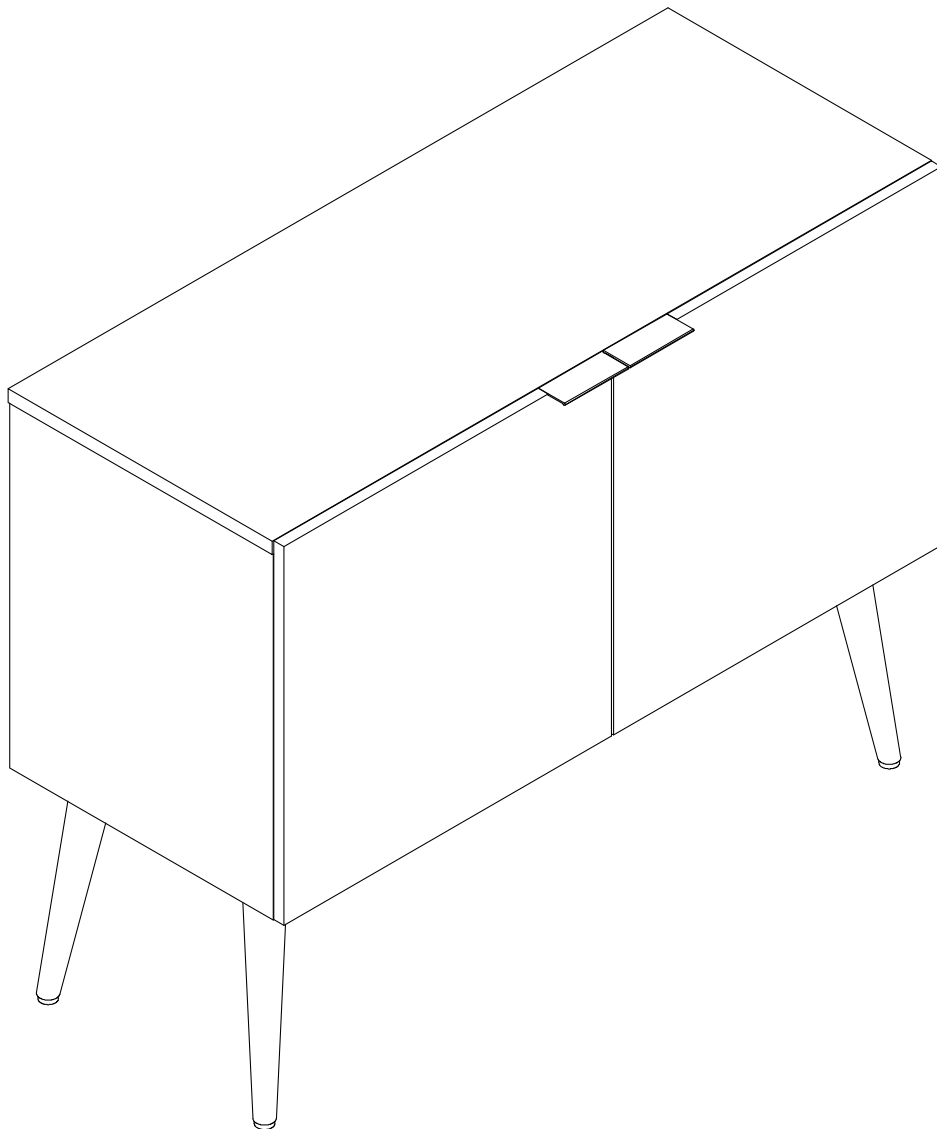

Version 1.0

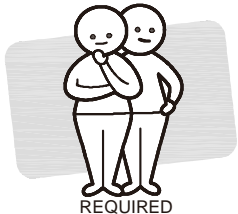

TWO PEOPLE



REQUIRED

MONACO

Buffet 2 Door

www.fantasticfurniture.com.au

Enjoy
Your purchase from
Australia's Best Value Furniture Store



**WARNING: ENSURE THE WALL BRACKET IS ATTACHED
TO AVOID SERIOUS INJURY.**

To avoid any serious or fatal injury, this product has been fitted with a wall bracket to prevent toppling. We strongly recommend that this product is permanently fixed to the wall or other suitable surface. Fixing devices are not included since different surface materials require different attachments. Please seek professional advice if you are in doubt of what fixing device to use.

Assembly checklist



Read through the instructions carefully before you begin.

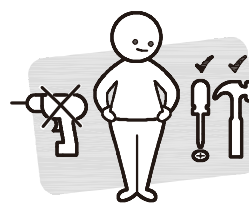

Make sure you have all the required tools. Never use power tools unless instructed.

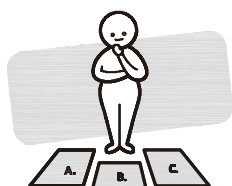

Identify and lay out all of the components before you begin assembly.

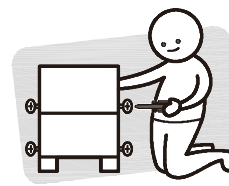

Unless instructed, do not fully tighten screws until the item is fully assembled.

Useful Information

!Never use power tools unless specifically instructed. They can damage your components or hardware if used incorrectly.

!The most common mistakes made during assembly are using the wrong hardware or getting components back to front.

!Always use a soft surface (such as carpet or cardboard) when assembling your product to avoid scratching or damaging the surface of the product.

!Bulky items such as wardrobes and bunk beds should be assembled in the room they will be used in as they may not fit through a door once assembled.

!Never use any glue until you are certain that the parts belong together.

! Periodically check and re-tighten all fasteners. Check the product care label or website for product care instructions.

!If you are having any difficulties assembling your product, missing any hardware or components please visit our website Help Centre for further assistance.

What you need

to assemble the product



DO NOT USE



Other tools you need

Flat head screwdriver; Phillips head screwdriver; Mallet

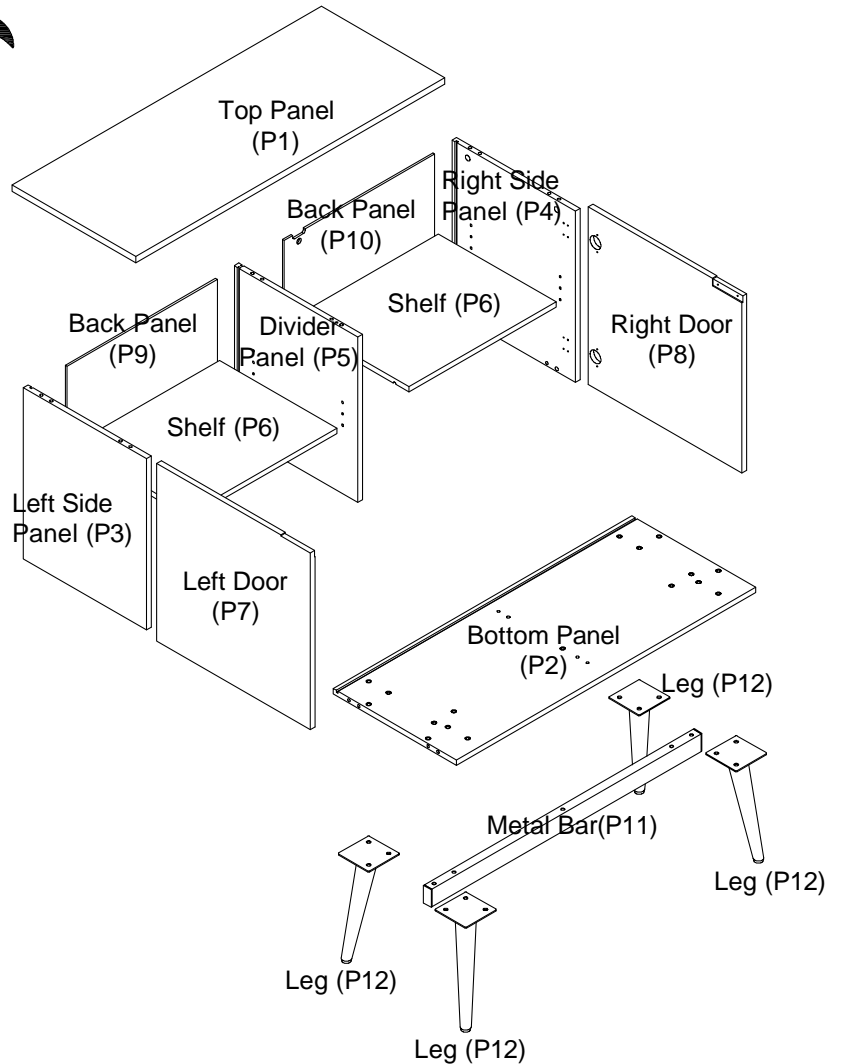

Part list

Box 1: Divider Panel (P5); 2x Shelf (P6); Left Door (P7); Right Door (P8); Left Back Panel (P9); Right Back Panel (P10); 4x Leg (P12); Hardware.

Box 2: Top Panel (P1); Bottom Panel (P2); Left Side Panel (P3); Right Side Panel (P4); Metal Bar (P11).

10 x Cam Bolt (H1)	10 x Cam Nut (H2)	22 x Black Cover (H3)	12 x Wood Dowel (H4)	4 x Hinge (H5)	25 x Screw (H6)
4 x Screw (H7)	2 x Screw (H8)	8 x Shelf Pin (H9)	1 x Allen Key (H10)	2 x Handle (H11)	1 x Wall Bracket (H12)
12 x Bolt (H13)	5 x Bolt (H14)	8 x Back Panel Connector (H15)	8 x Screw (H16)	4 x Plastic Bumper (H17)	

Step 1

You will need	
6 x Cam Bolt (H1)	1 x Wall Bracket (H12)
1 x Screw (H6)	Phillips head screwdriver

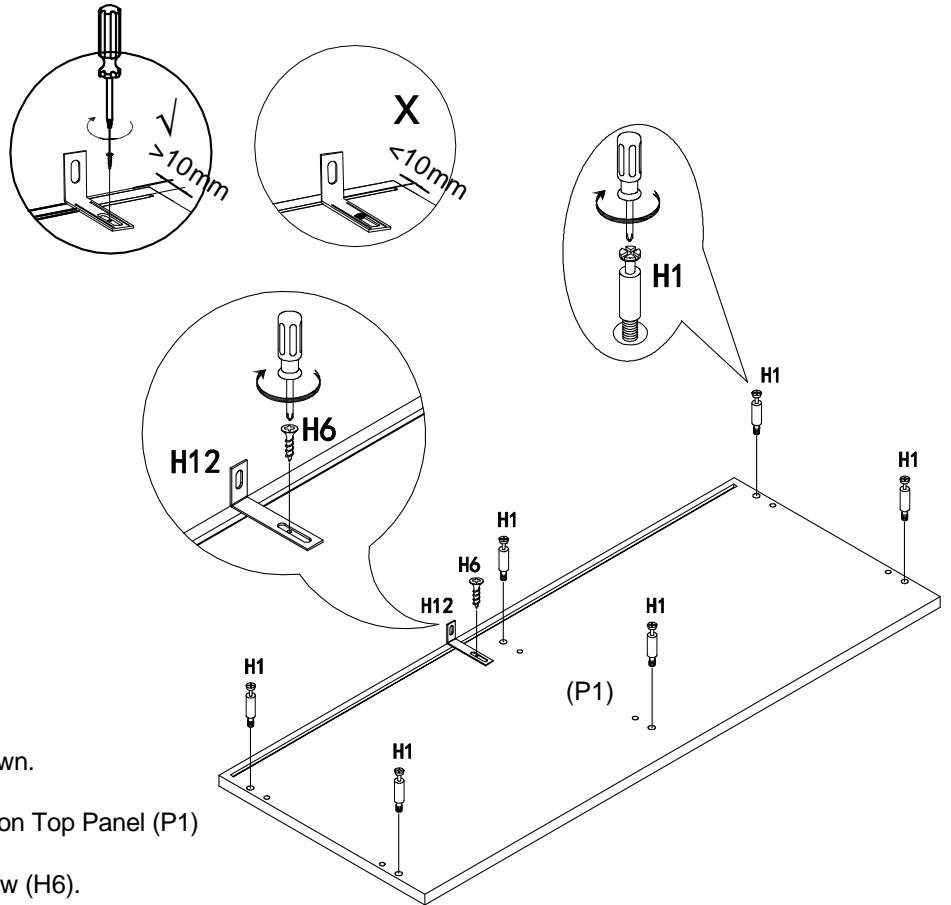

Screw 6 x Cam Bolts (H1) into Top Panel (P1) as shown.

Fasten Wall Bracket (H12) on Top Panel (P1) with screw (H6).
Do not fully tighten the Screw (H6).

Step 2

You will need	
4 x Cam Bolt (H1)	4 x Wood Dowel (H4)
Phillips head screwdriver	Mallet

Insert 2 x Wood Dowels (H4) into Right Side Panel (P4).
Screw 2 x Cam Bolts (H1) into Right Side Panel (P4).

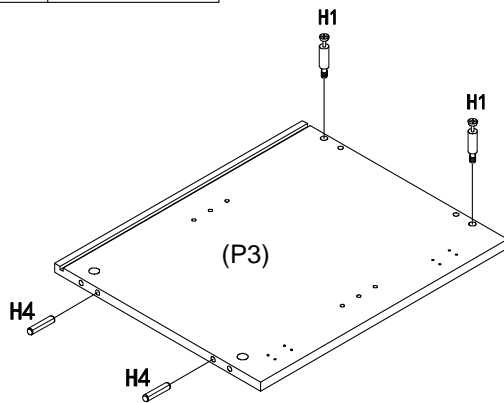
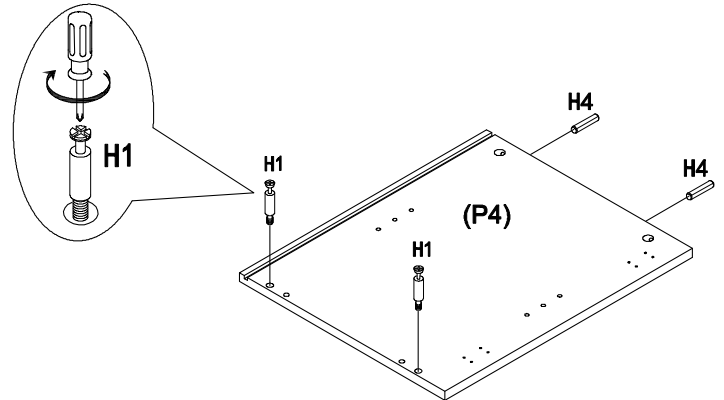

Insert 2 x Wood Dowels (H4) into Left Side Panel (P3).
Screw 2 x Cam Bolts (H1) into Left Side Panel (P3).

Step 3

You will need	
	
4 x Wood Dowels (H4)	Mallet

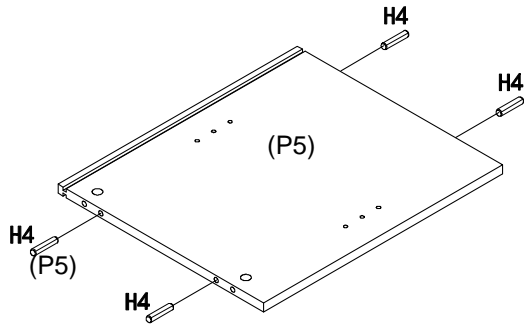

Insert 4 x Wood Dowels (H4) into Divider Panel (P5).

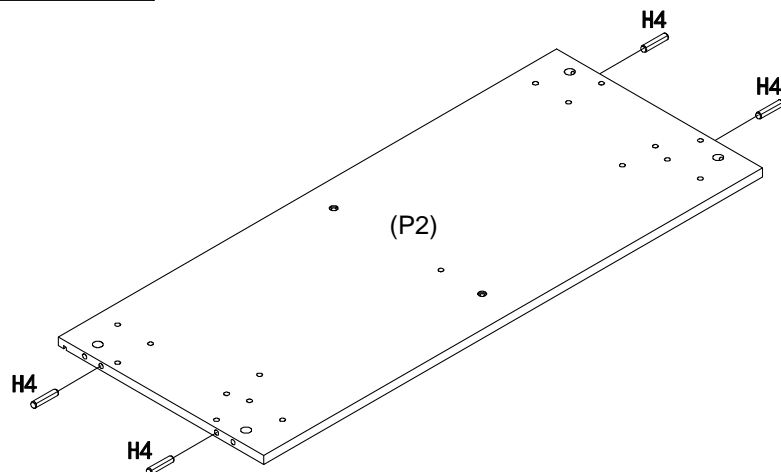

Step 4

You will need	
	
4 x Wood Dowels (H4)	Mallet



Insert 4 x Wood Dowels (H4) into Bottom Panel (P2).

Step 5

You will need	
	
2 x Screw (H8)	Allen Key (H10)

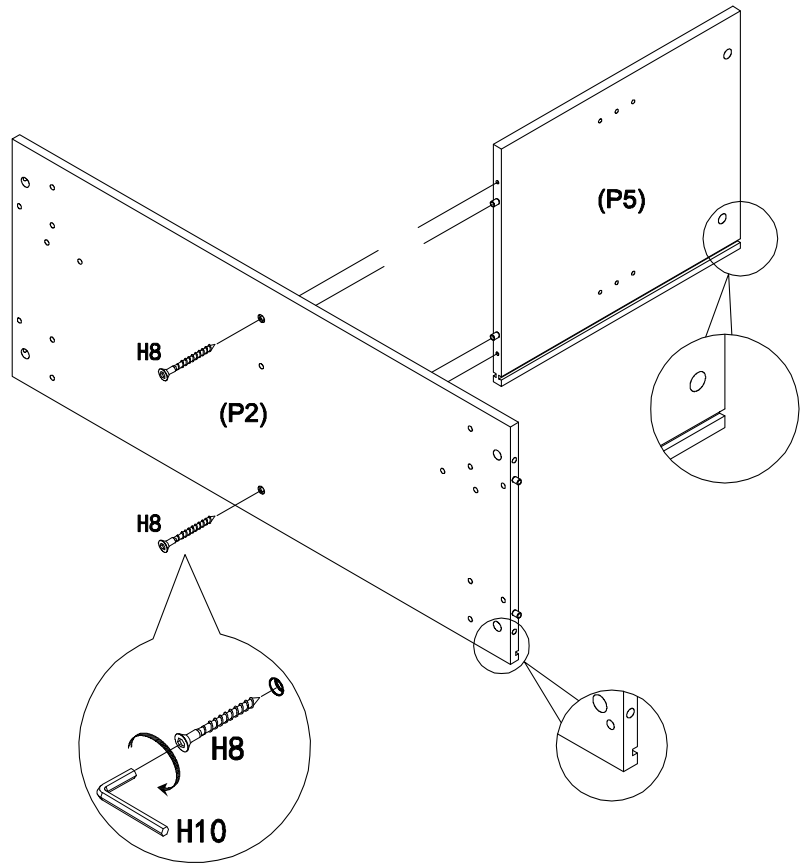

Position the Divider Panel (P5) so that its grooves are aligned to the Bottom Panel (P2) and the cam nut holes are furthest away from Bottom Panel (P2).

Fit the Panels together.
Screw in 2 x Screws (H8) into Bottom Panel (P2) with Allen Key (H10).

Step 6

You will need	
	
4 x Cam Nut (H2)	Flat head screwdriver

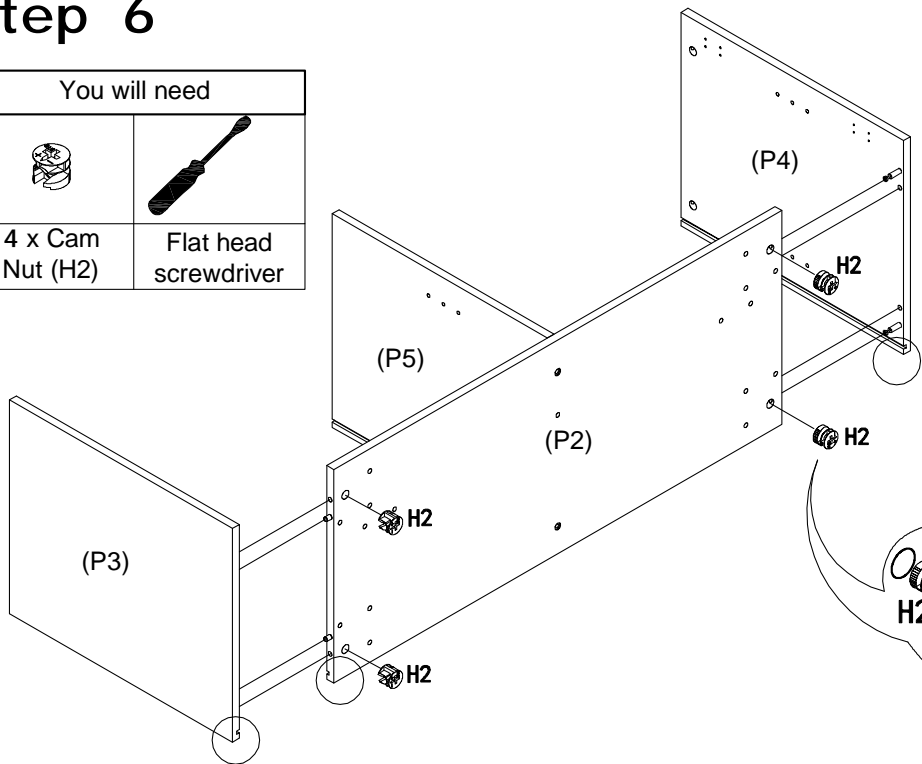

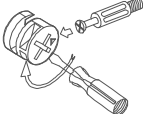

This is how a cam nut works.....

 The head of the cam bolt goes into the open mouth of the cam nut. You then turn the cam nut so it tightens over the bolt.

Position Left Side Panel (P3) and Right Side Panel (P4) onto Bottom Panel (P2), so that their grooves are aligned.

Insert 4 x Cam Nuts (H2) into Bottom Panels (P2) and turn clockwise to lock.

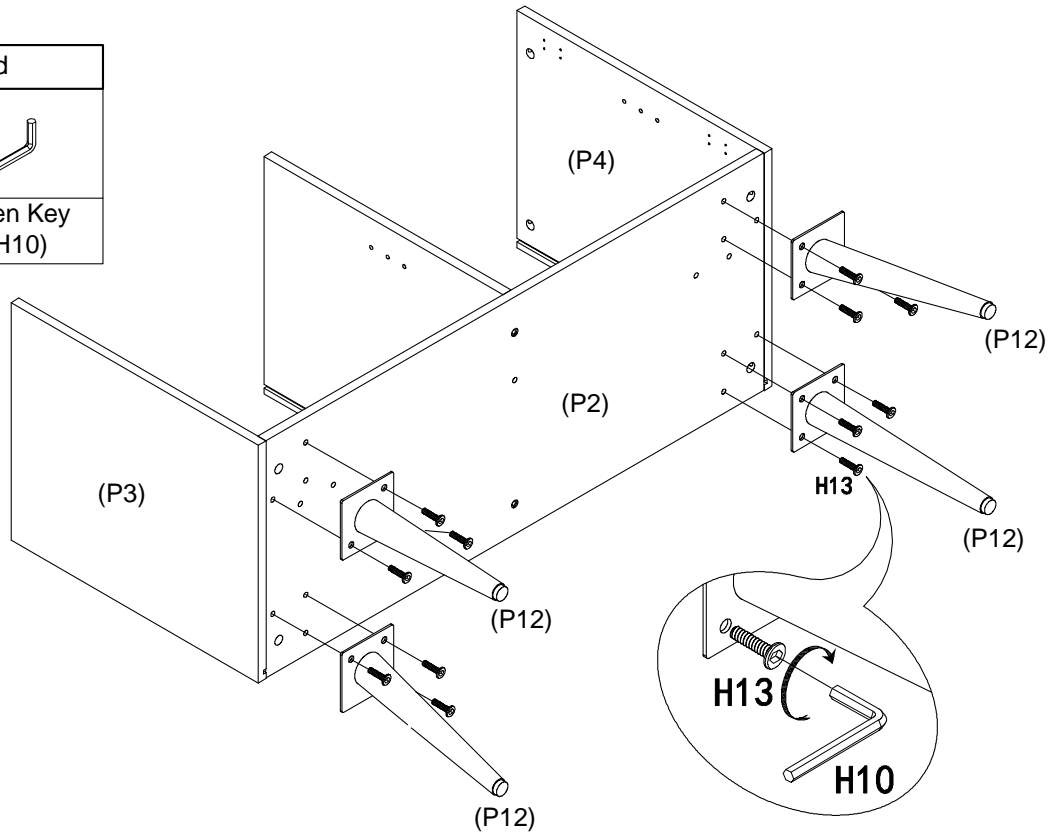

Step 7

You will need	
	
12 x Bolt (H13)	Allen Key (H10)



Fix each Metal Leg (P12) to Bottom Panel (P2) with 3 x Bolts (H13) using Allen Key (H10).

Step 8

You will need	
	
5 x Bolt (H14)	Allen Key (H10)

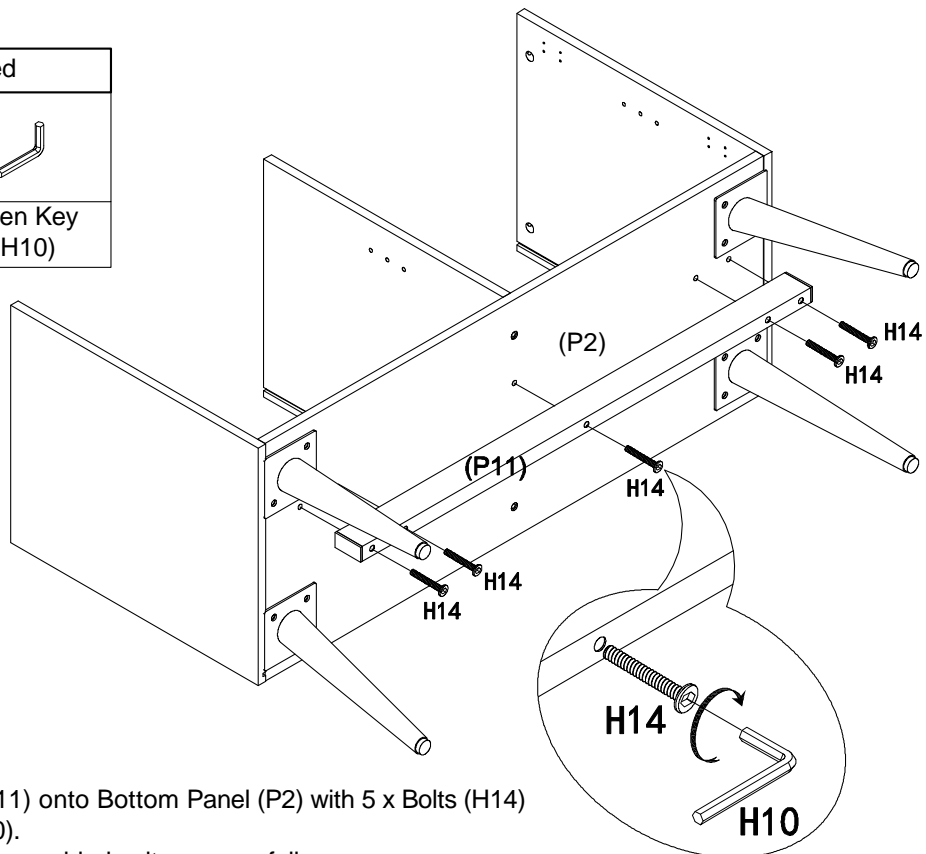

Attach Metal Bar (P11) onto Bottom Panel (P2) with 5 x Bolts (H14) using Allen Key (H10).

With help, turn the assembled unit over carefully.

Step 9

You will need	
	
16 x Black Cover (H3)	

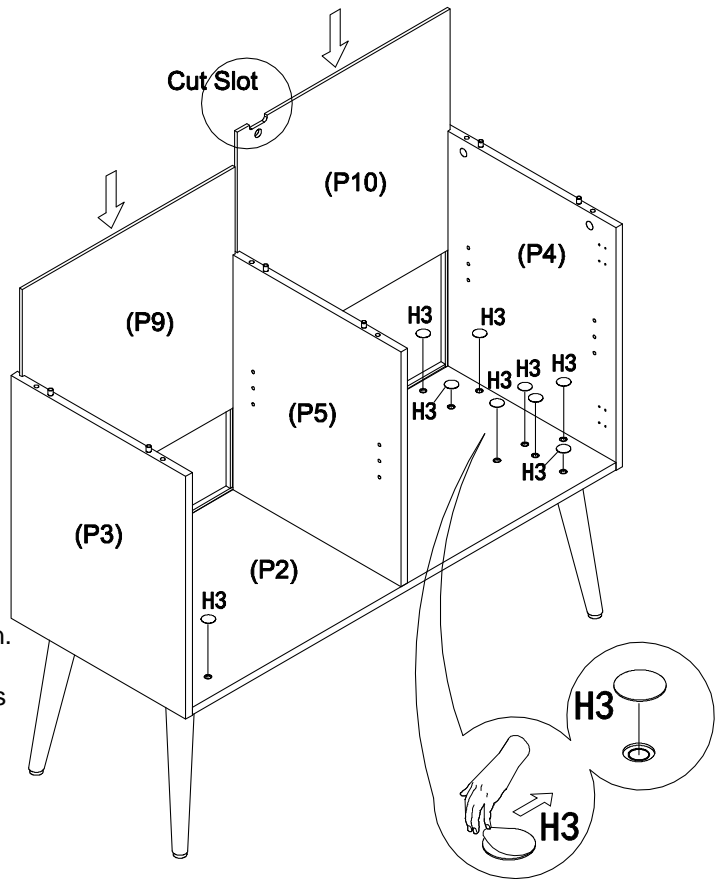



Slide Left Back Panel (P9) into the grooves as shown.

Position Right Back Panel (P10) so that the cut slot is on the left and facing the direction as shown. Slide Back Panel (P10) into the grooves as shown.

Paste 16 x Black Cover (H3) on the holes of Bottom Panel (P2).

Step 10

You will need	
	
6 x Cam Nut (H2)	6 x Black Cover (H3)
	
Flat head screwdriver	

This is how a cam nut works.....

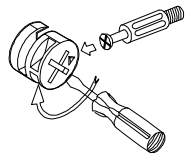

The head of the cam bolt goes into the open mouth of the cam nut. You then turn the cam nut so it tightens over the bolt.

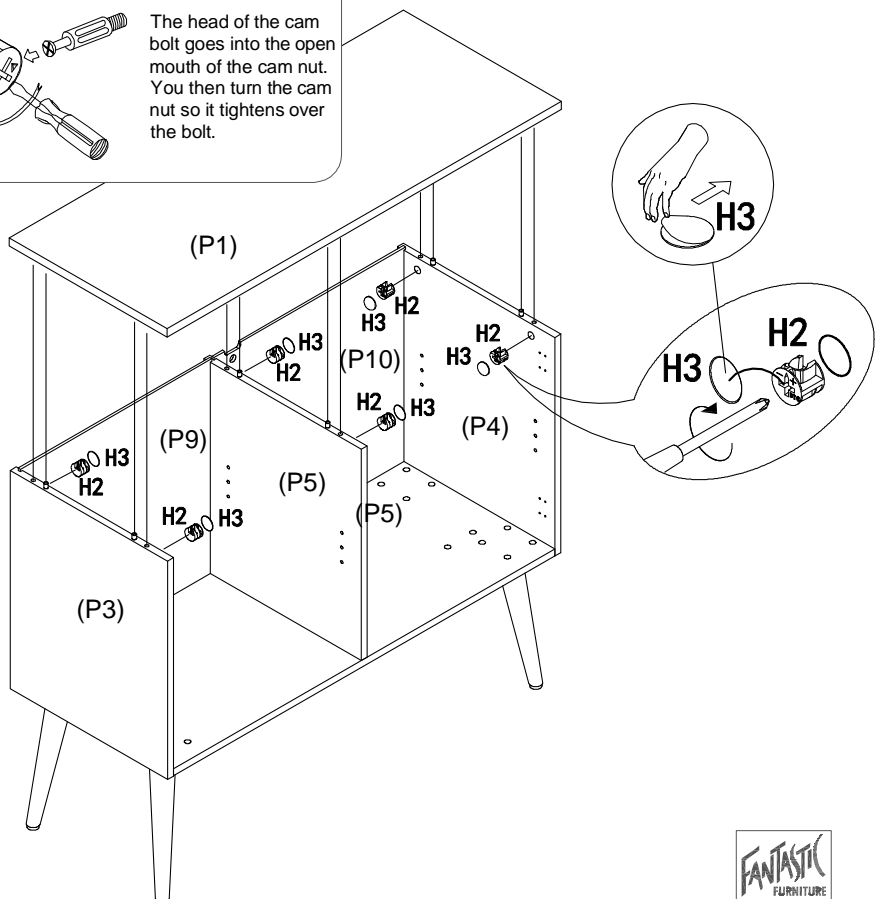

Position Top Panel (P1) onto Side Panel (P3) & (P4), Divider Panel (P5) and Back Panels (P9) and (P10).

Insert 6 x Cam Nuts (H2) into Side Panel (P3) & (P4), Divider Panel (P5) and turn clockwise to lock.

Paste 6 x Black Cover (H3) on Cam Nuts (H2) on Cam Nuts (H2).

Step 11

If necessary, gently adjust the Top Panel (P1) sideways in either direction until XX and YY are equal.

You will need	
8 x Back Panel Connector (H15)	8 x Screw (H16)
Phillips head screwdriver	

Fix the Back Panel Connectors (H15) with Screws (H16) as shown.

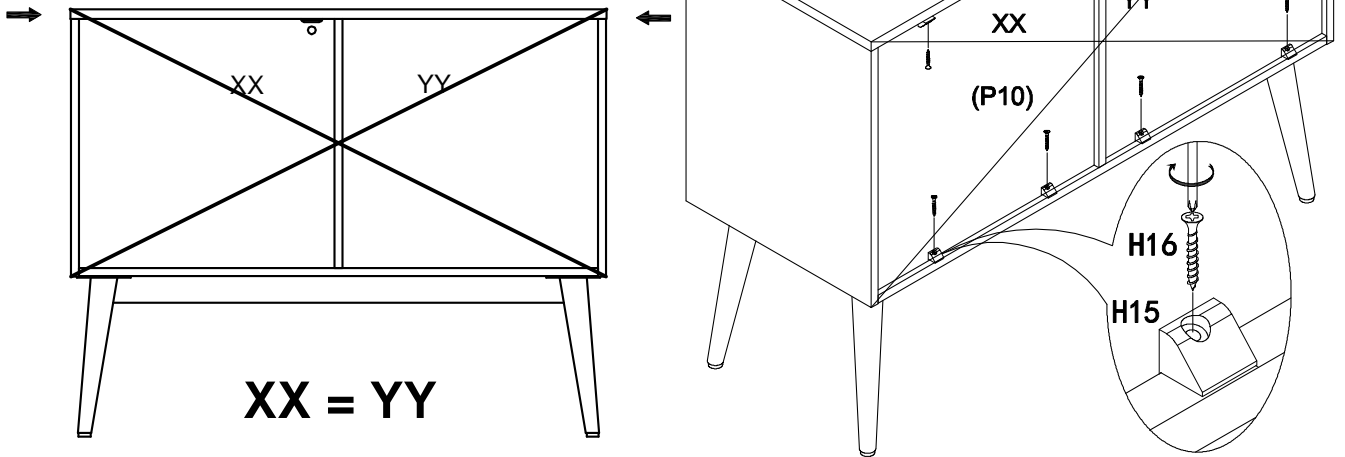

Step 12

You will need	
Phillips head screwdriver	

Seek advice from a qualified trades person on how to attach this safety Bracket to your specific wall.



We strongly advise that you use the wall safety Bracket provided to prevent the unit toppling.

Screw and Wall Plug are not provided. Please use appropriate fixtures for your wall.

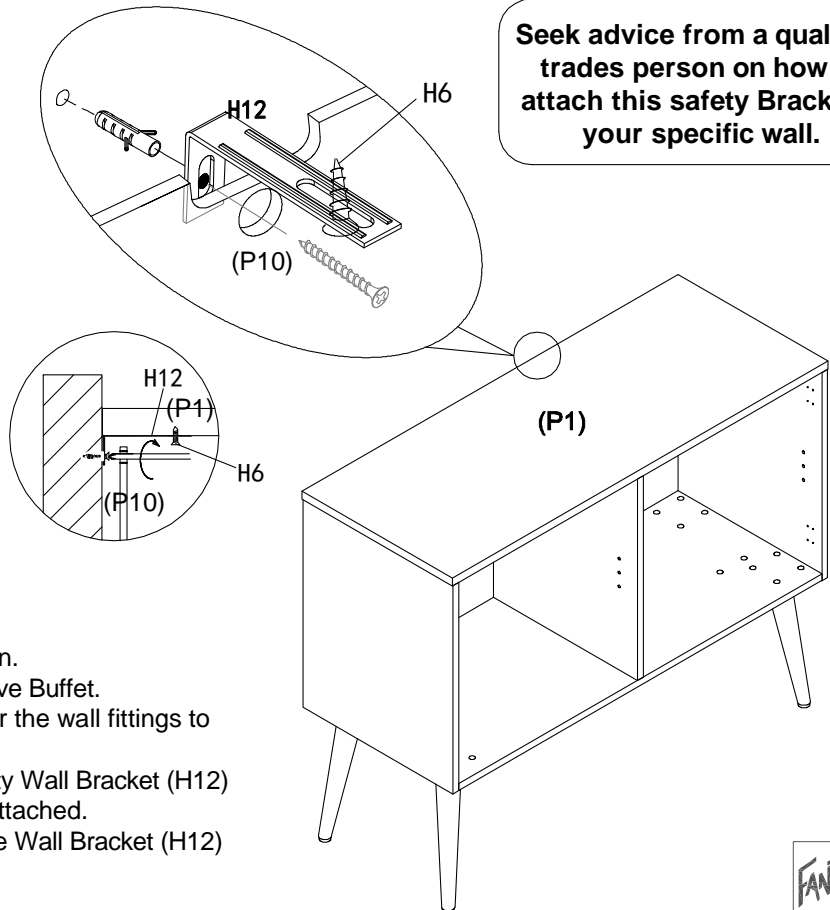
Move the Buffet to the final position. Mark fixing hole on wall and remove Buffet. Follow the instructions provided for the wall fittings to mount the fittings to the wall. Reposition Buffet and fix the safety Wall Bracket (H12) to the wall. Make sure it is firmly attached. Fully tighten the screw (H6) on the Wall Bracket (H12) to the Top Panel (P1).



Step 13



You will need	
	
4 x Hinge (H5)	8 x Screw (H6)
	
Phillips head screwdriver	

Attach 2 x Hinges (H5) to Left Door (P7) with 4 x Screws (H6).

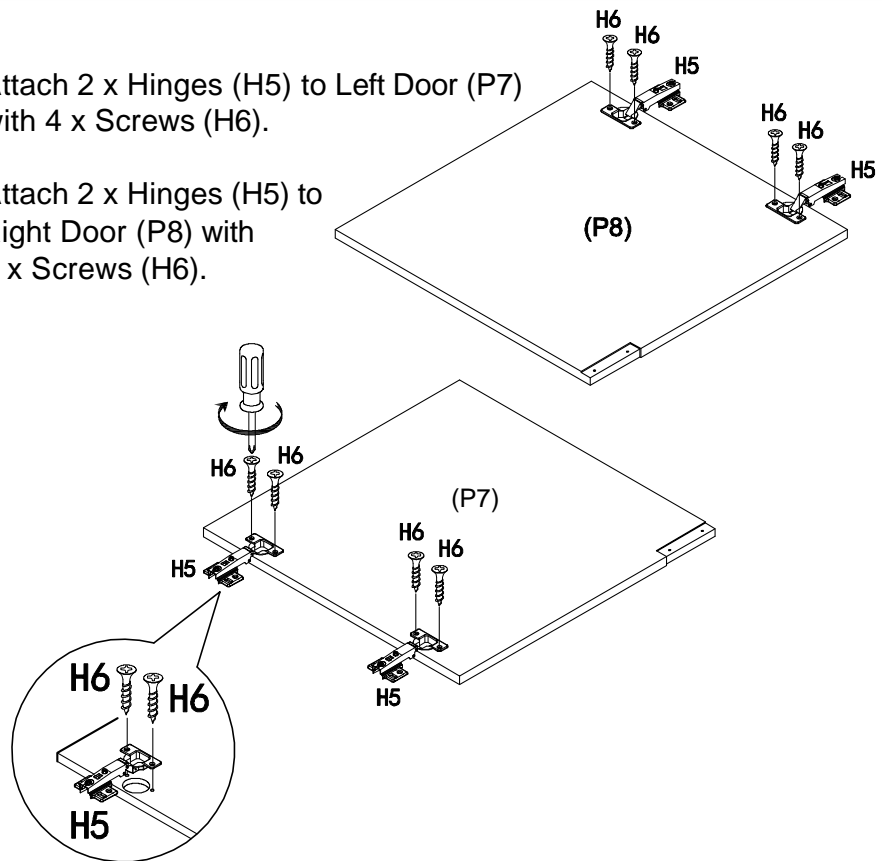
Attach 2 x Hinges (H5) to Right Door (P8) with 4 x Screws (H6).



Step 14

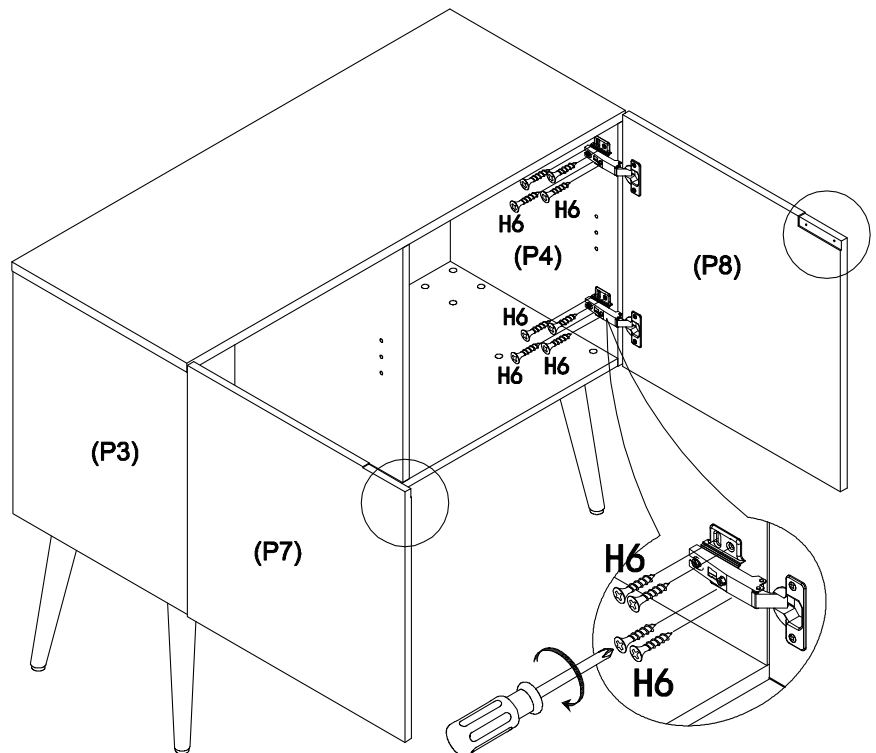

You will need	
	
16 x Screw (H6)	Phillips head screwdriver



Attach 2 hinges on Left Door (P7) to Left Side Panel (P3) with 8 x Screws (H6) as shown.

Attach 2 hinges on Right Door (P8) to Right Side Panel (P4) with 8x Screws (H6) as shown.

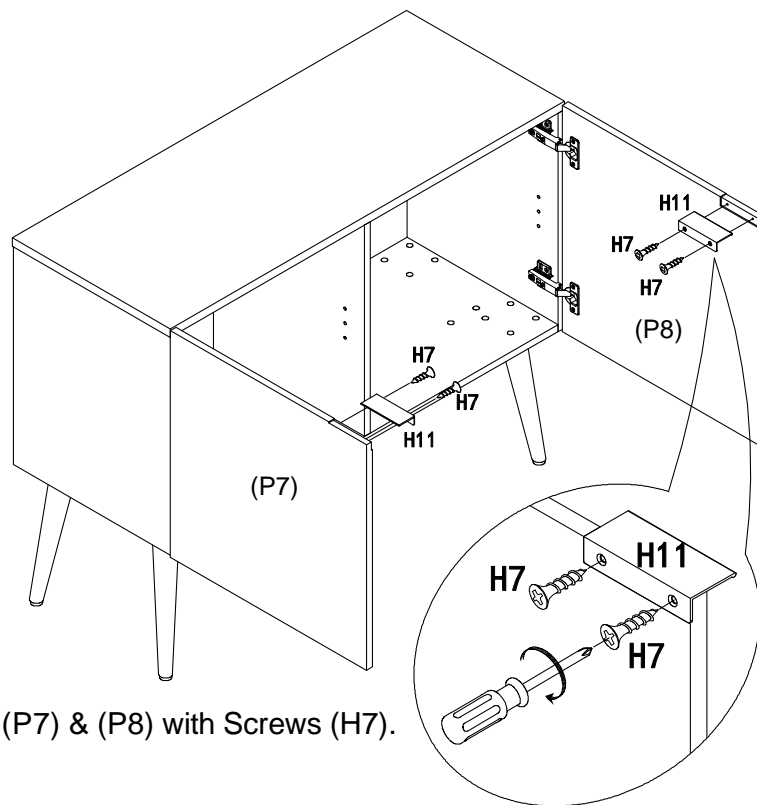

Step 15

You will need	
	
2 x Metal Handle (H11)	4 x Screw (H7)
	
Phillips head screwdriver	



Attach Metal Handles (H11) to Doors (P7) & (P8) with Screws (H7). Do not over-tighten the screws (H7).

Step 16

You will need	
	
8 x Shelf Pin (H9)	4 x Plastic Bumper (H17)

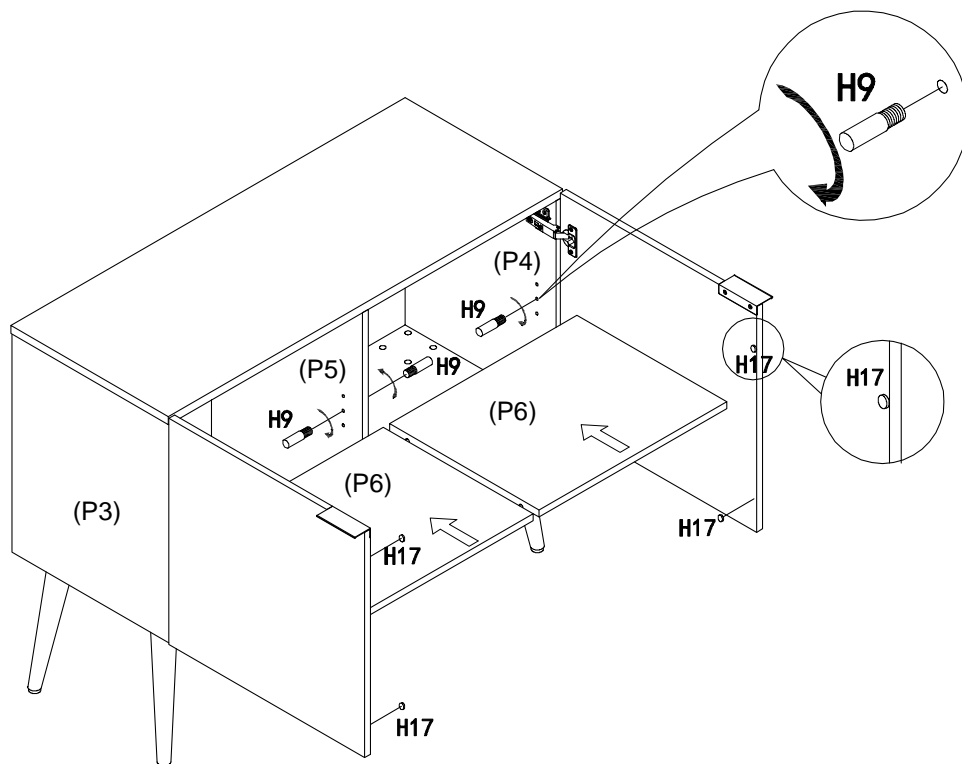

Screw 8x Shelf Pins (H9) into Side Panel (P3) & (P4) and Divider Panel (P5). Rest 2x Shelves (P6) on Shelf Pins (H9).

Paste Plastic Bumper (H17) on Doors edge as shown.

Step 17

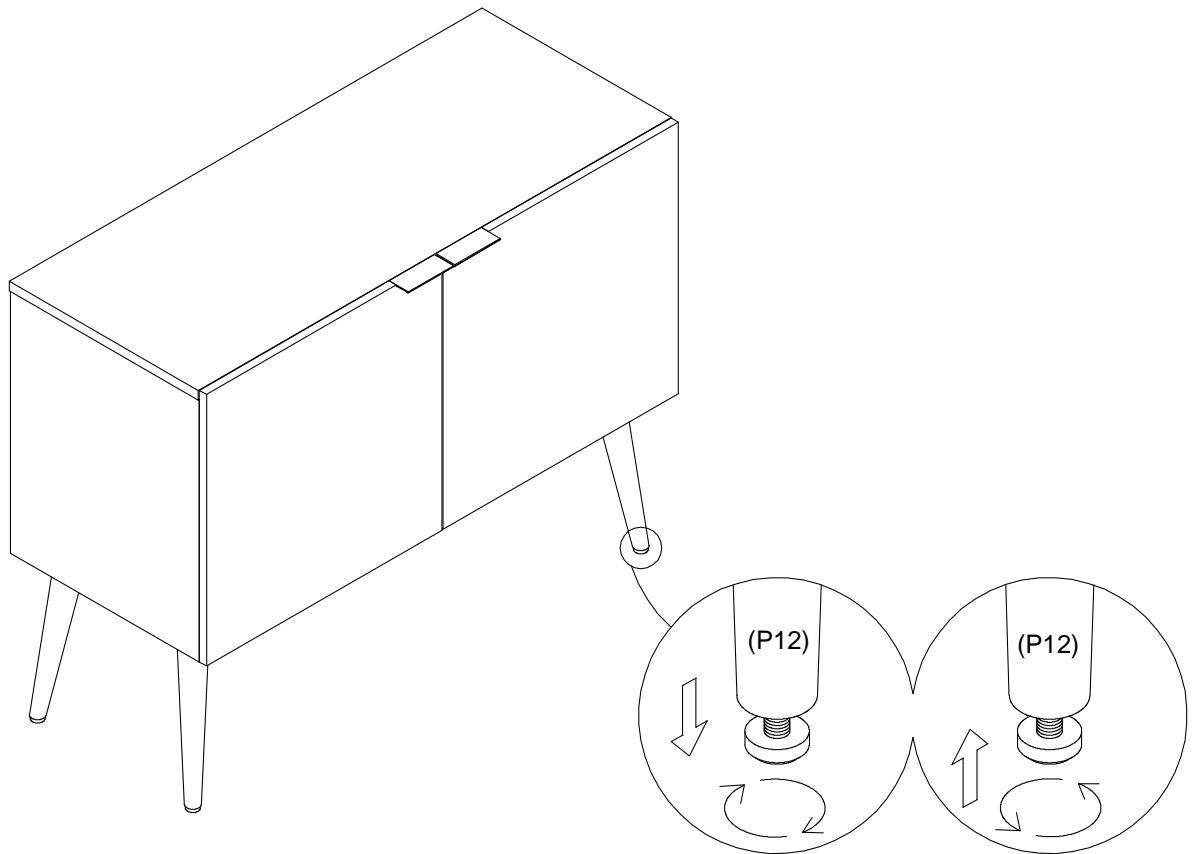

If the Buffet is not level, you can adjust the Legs height by turning the feet of Legs (P12) clockwise or counter-clockwise.

Step 18

TO ADJUST YOUR DOORS TO MAKE THE GAPS MORE EVEN (OPTIONAL).

You will need	
	
Phillips head screwdriver	

STEP 18.1
Open the door.

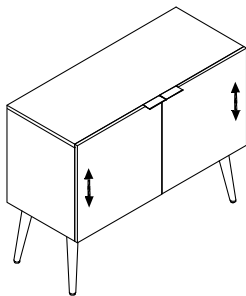
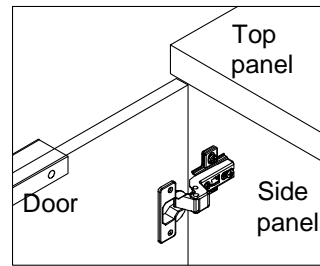

STEP 18.2
Adjust the door panels upward or downward

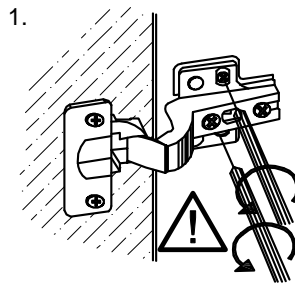

1. Unscrew 2 screws in round holes
Loosen 2 screws in oval holes a bit.

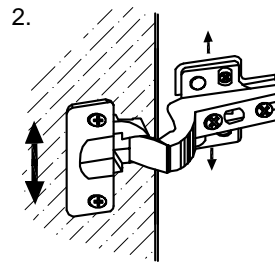

2. MOVE DOOR UPWARD OR DOWNWARD

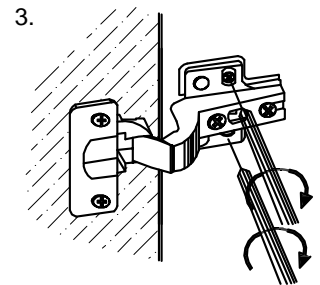

3. Tighten 2 screws in oval holes.
Screw in 2 screws in round holes

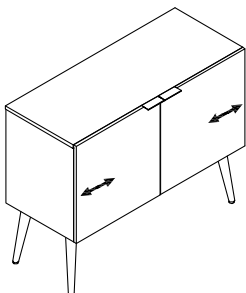

STEP 18.3
Adjust the flush between door panel and side panel

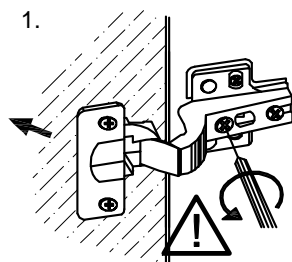

1. MOVE DOOR OUTWARD by turning this screw counter-clockwise

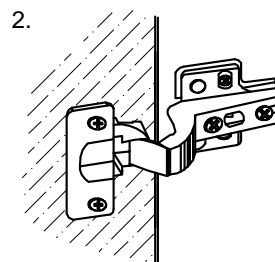

2. KEEP DOOR IN RIGHT POSITION

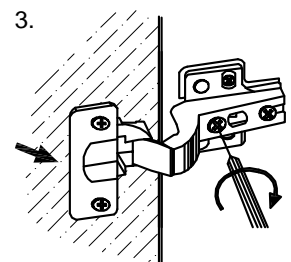

3. MOVE DOOR OUTWARD by turning this screw clockwise

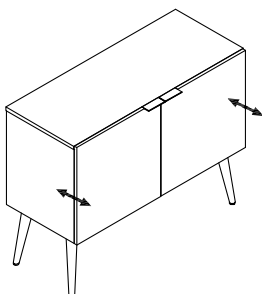

STEP 18.4
Adjust the gap between door panel and side panel

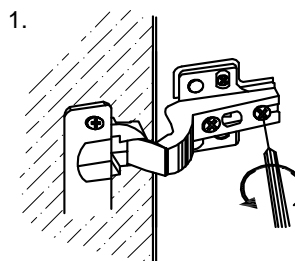

1. Loosen this screw a bit.

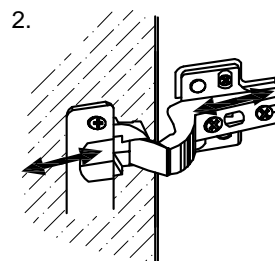

2. MOVE DOOR BACK OR FORTH

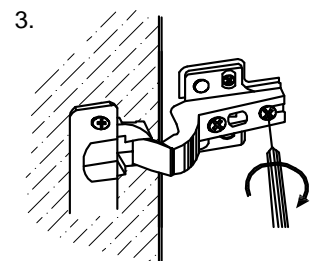

3. Re-tighten this screw.

Step 19

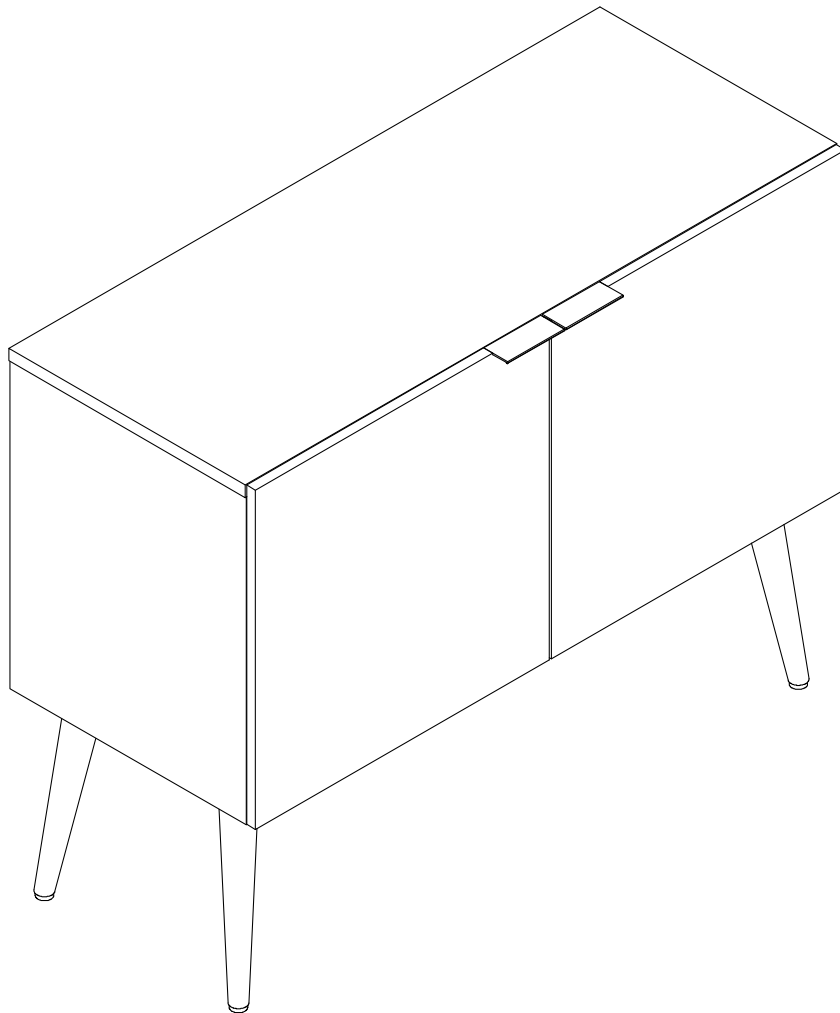

Job Complete !

In the interest of our environment Please dispose of all packaging thoughtfully.



THIS TOP IS FINISHED WITH A CLEAR PU LACQUER

Avoid placing hot items directly onto the surface unless using a thick insulation material such as placemats or coasters. Heat may lead to discolouration or other damage to the surface of the product.

Use a soft cloth that has been dampened in water to clean the surface of this product. Do not use abrasive cleaners, furniture wax or polish on the surface of this product, as it may damage the surface.

CAUTION: FREQUENT EXPOSURE TO DIRECT SUNLIGHT OR SIMILAR SOURCES MAY CAUSE THE SURFACE TO DISCOLOUR OR FADE.