

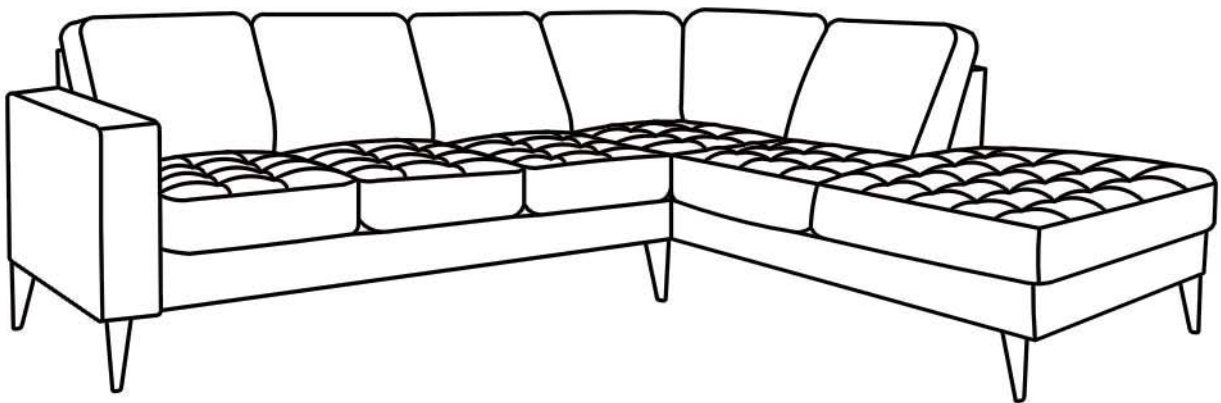

Version 1.0

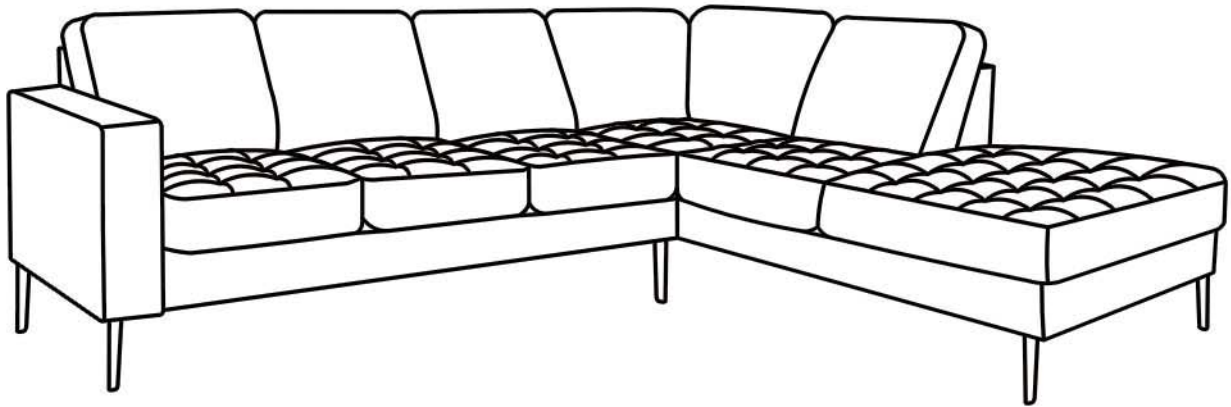

TWO PEOPLE

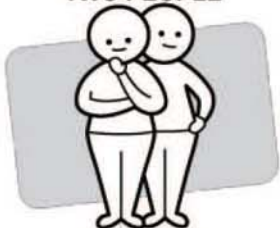

REQUIRED

FINLAY

Modular Chaise Raf

Enjoy

Your purchase from
Australia's Best Value Furniture Store



Assembly checklist



Read through the instructions carefully before you begin.

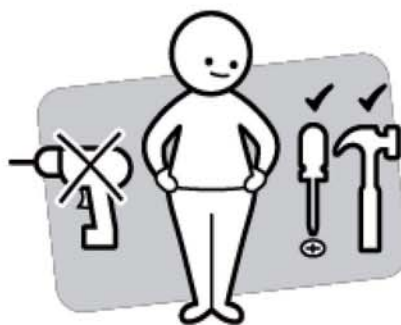

Make sure you have all the required tools. Never use power tools unless instructed.



Identify and lay out all of the components before you begin assembly.

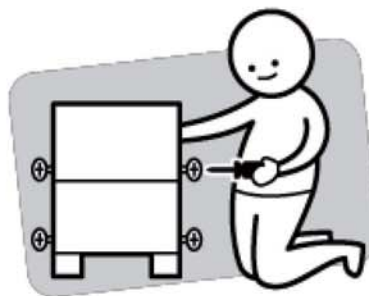

Unless instructed, do not fully tighten screws until the item is fully assembled.

Useful Information

- ! Never use power tools unless specifically instructed. They can damage your components or hardware if used incorrectly.
- ! The most common mistakes made during assembly are using the wrong hardware or getting components back to front.
- ! Always use a soft surface (such as carpet or cardboard) when assembling your product to avoid scratching or damaging the surface of the product.
- ! Bulky items such as wardrobes and bunk beds should be assembled in the room they will be used in as they may not fit through a door once assembled.
- ! Never use any glue until you are certain that the parts belong together.
- ! Periodically check and re-tighten all fasteners. Check the product care label or website for product care instructions.
- ! If you are having any difficulties assembling your product, missing any hardware or components please visit our website Help Centre for further assistance.

What you Need:

to assemble the product



DO NOT USE

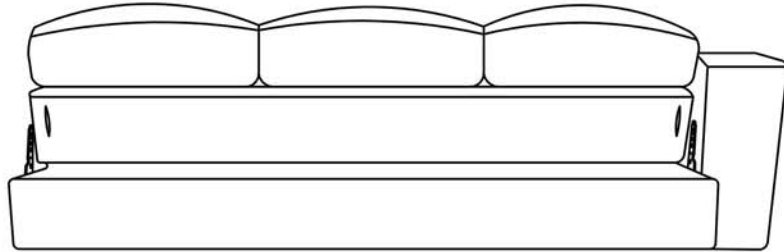

Modular Chaise Raf 1 of 2

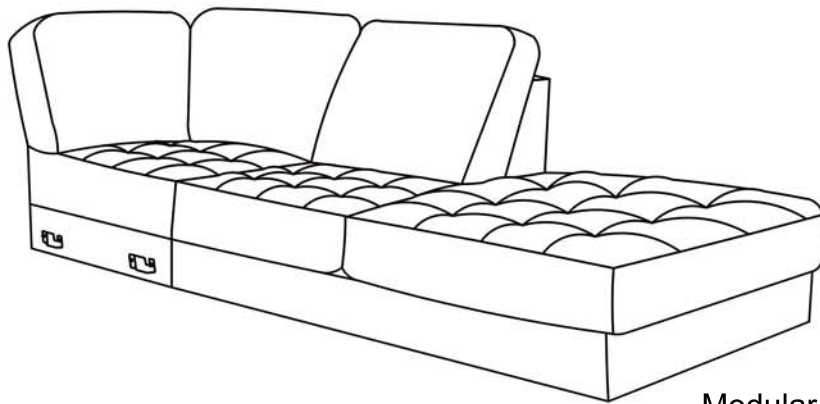

Modular Chaise Raf 2 of 2

Parts list:

Box 1 :Metal Leg

Box 2 :Wooden Leg

BOX 1:

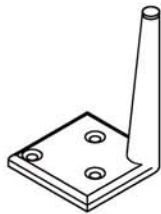

H1
8 X LEGS



H2
24 X BOLTS



H3
2 X ALLEN KEYS



H4
1 X LEG

BOX 2:

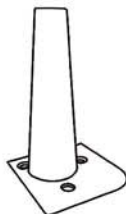

H1
8 X LEGS



H2
24 X BOLTS



H3
2 X ALLEN KEYS



H4
1 X LEG

Step 1

Place each piece on a flat, clean surface as shown and remove hardware boxes from the pocket underneath.

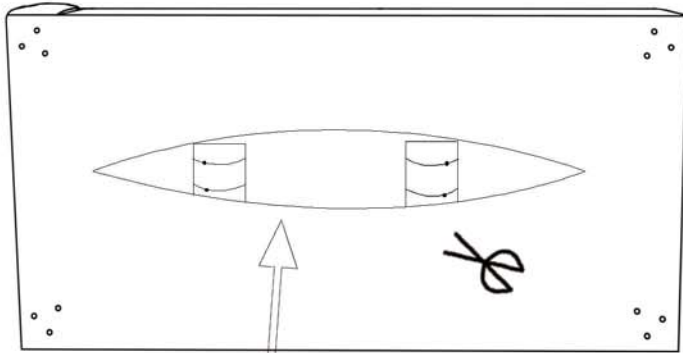
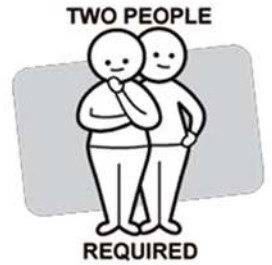

Modular Chaise Raf 1 of 2

Note:
Here are two hardware boxes.

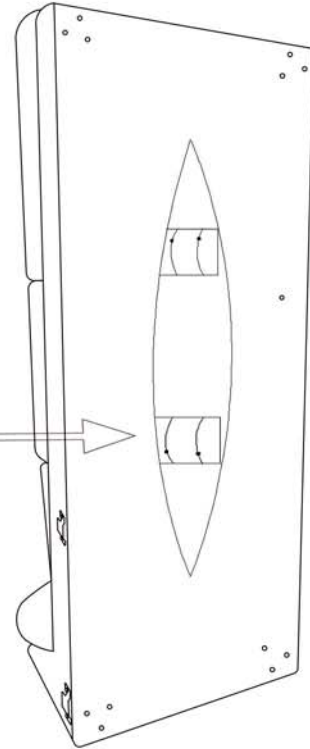

Modular Chaise Raf 2 of 2

Cut the plastic bandage and remove hardware boxes from the pocket underneath.

Step 2

BOX 1:

You will need:			
8 X LEGS (H1) (Per piece)		24 X BOLTS (H2) (Per piece)	
2 X ALLEN KEYS (H3) (Per piece)		1 X LEG (H4) (Per piece)	

BOX 2:

You will need:			
8 X LEGS (H1) (Per piece)		24 X BOLTS (H2) (Per piece)	
2 X ALLEN KEYS (H3) (Per piece)		1 X LEG (H4) (Per piece)	

Box 1 and Box 2 are installed in the same way.

TWO PEOPLE



Attach 4 X legs (H1) into position as shown with 12 X bolts (H2) using an allen key (H3).

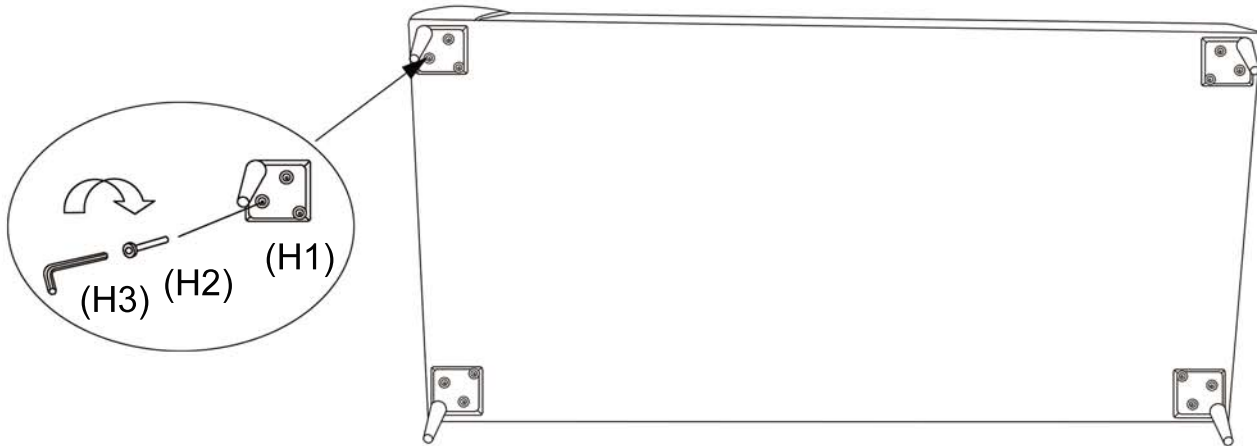

Modular Chaise Raf 1 of 2

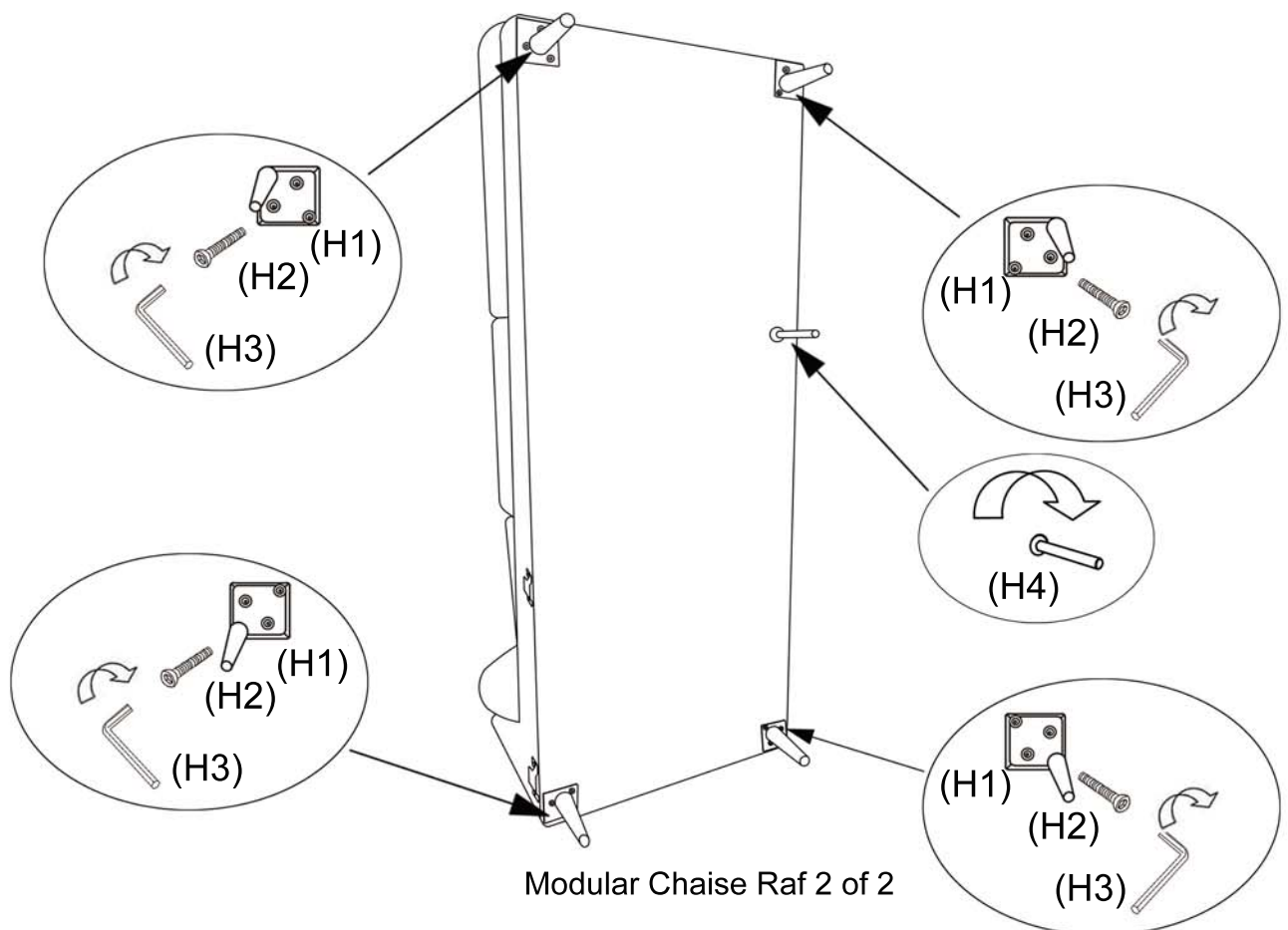

Modular Chaise Raf 2 of 2

Attach 4 X legs (H1) into position as shown with 12 X bolts (H2) using an allen key (H3).

Attach 1 X leg (H4) into position as shown.

Step 3

TWO PEOPLE

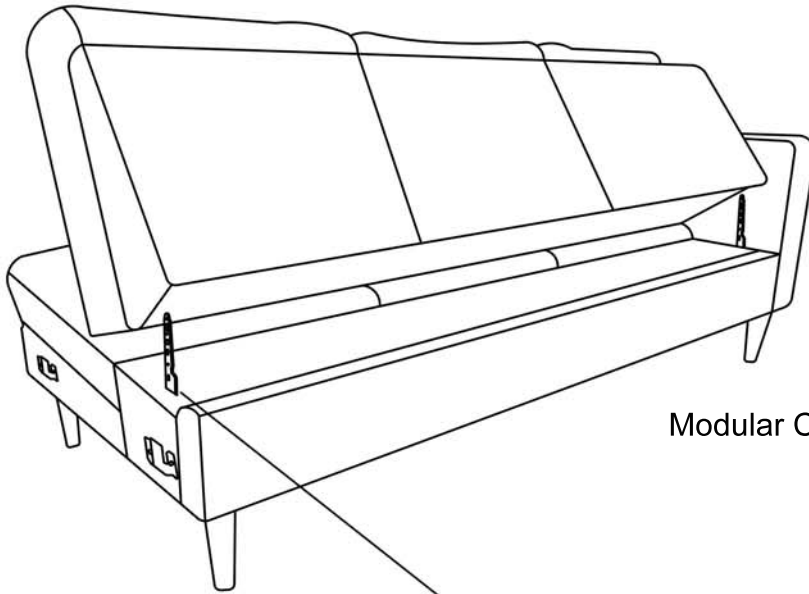

Modular Chaise Raf 1 of 2

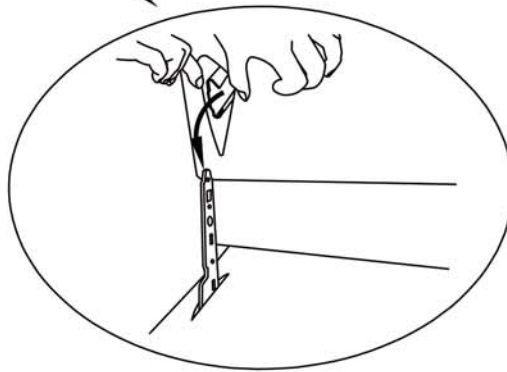
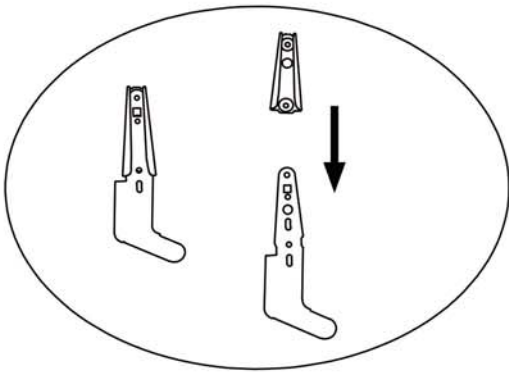

Align the grooves together, and install the back securely. Push the back piece down and listen for the click, ensure the back piece is fully locked into position.

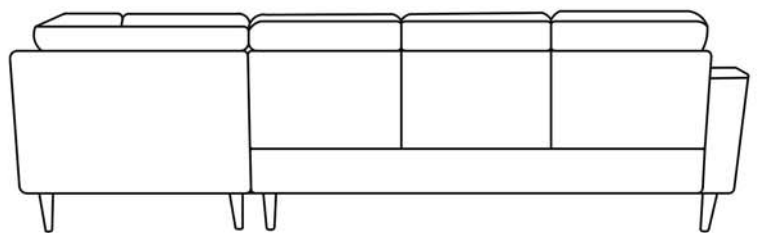

To take the back piece off, push down the arm rests and then carefully pull the back piece up.

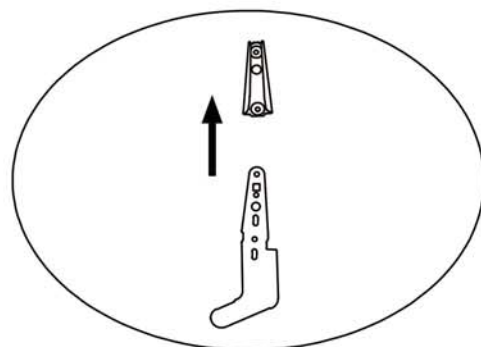
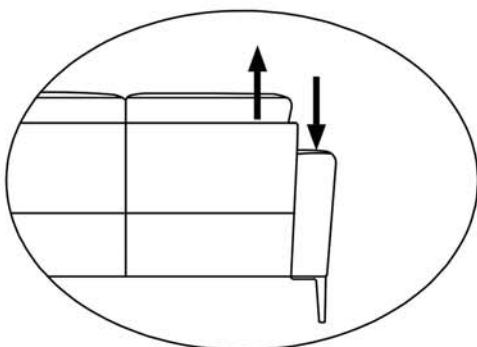

Step 4

Align the clips and join the 2 pieces together.

TWO PEOPLE

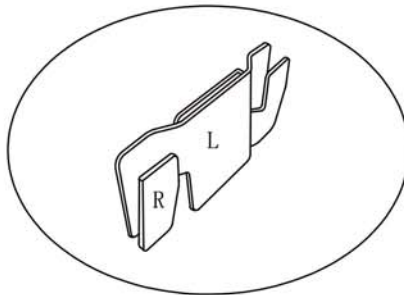
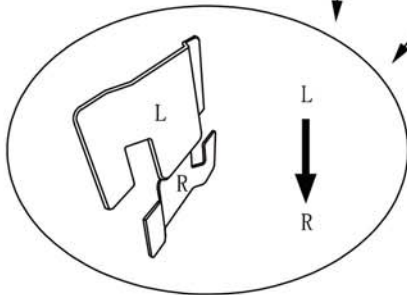
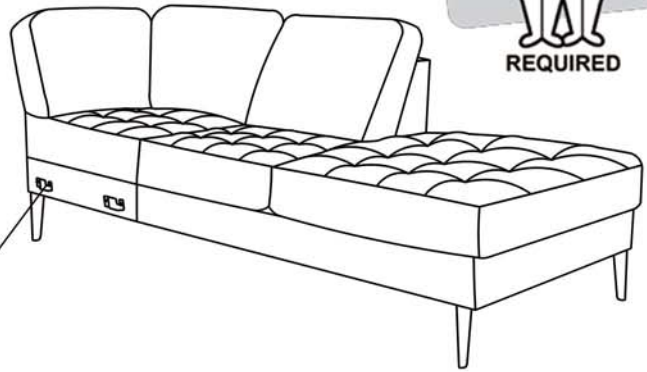
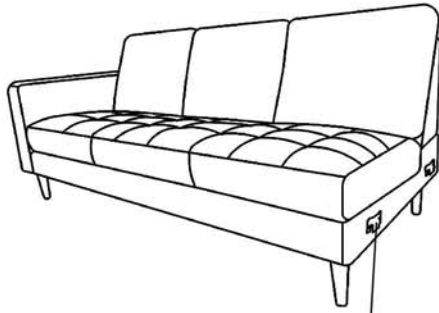

Step 5

Place your sofa into position.

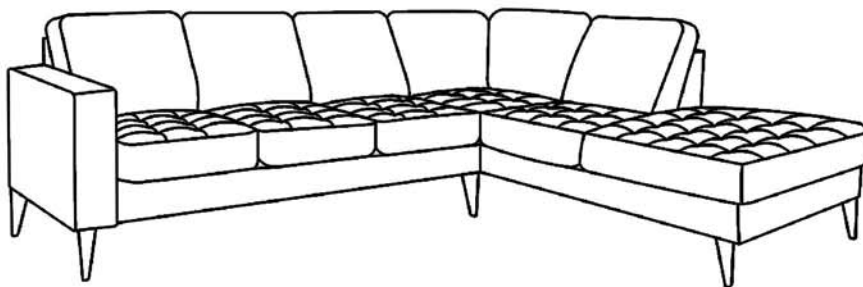
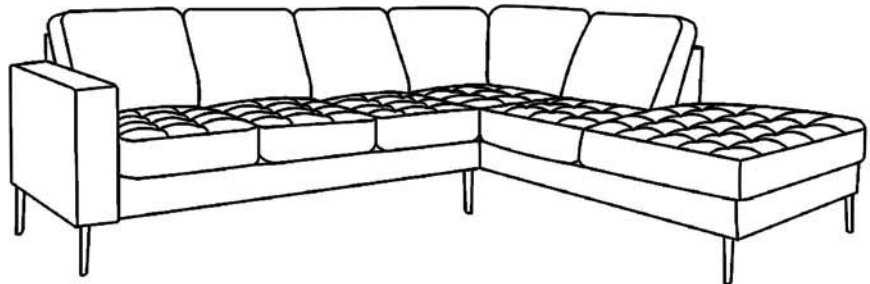

Modular Chaise Raf

Job Complete!

In the interest of our environment please dispose of all packaging thoughtfully.