

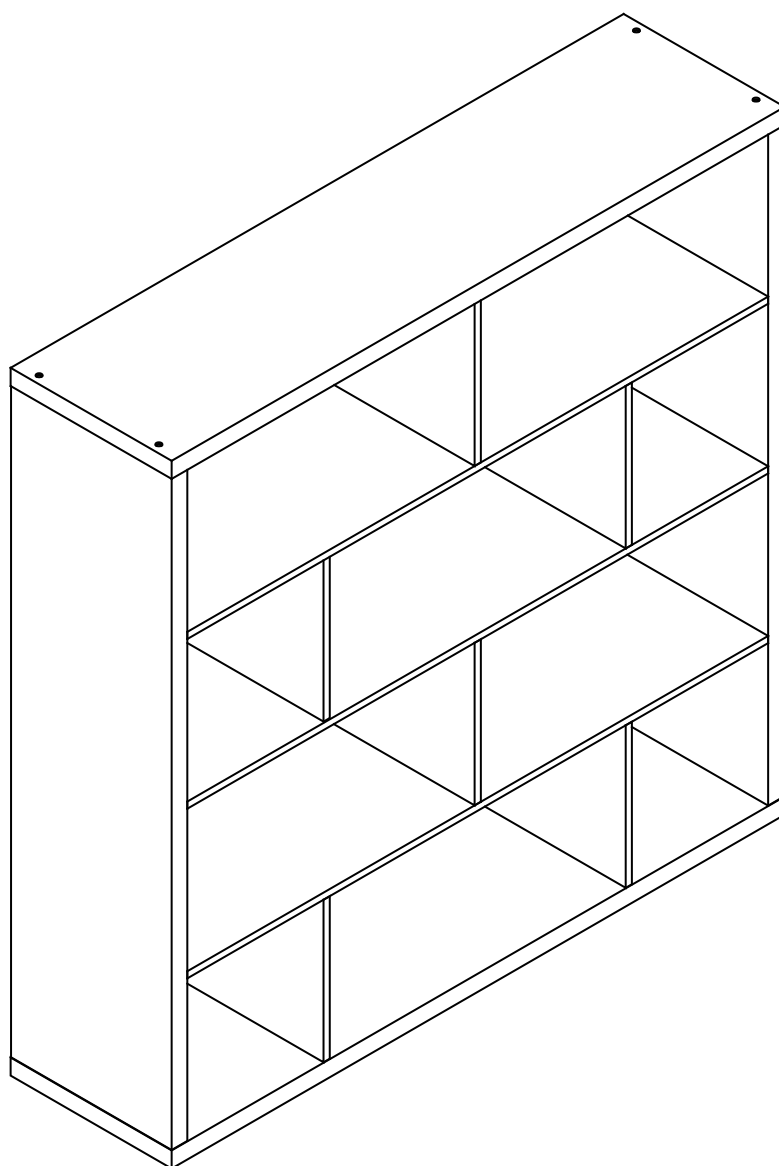

**Fantastic
Furniture**

Version 1.0



Two People

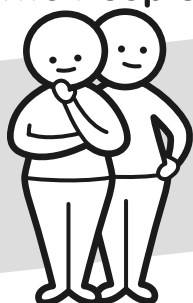

Required

Coda
Bookcase 10 Shelf

fantasticfurniture.com.au

Secure it!

Reduce the risk of furniture tip-over accidents

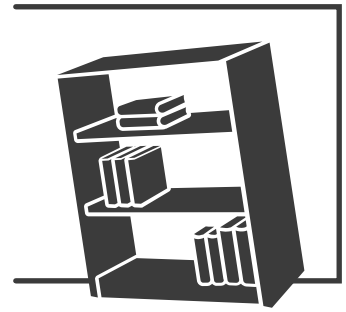

WARNING: ENSURE THE WALL STRAP IS ATTACHED TO AVOID SERIOUS INJURY OR DEATH.

To avoid any serious or fatal injury, a wall strap has been provided with this product to prevent toppling. We strongly recommend that this product is permanently fixed to the wall or other suitable surface. Fixing devices are not included since different surface materials require different attachments. Please seek professional advice if you are in doubt of what fixing device to use.

Recommended Weight Capacity :10kg/shelf

To reduce the risk of furniture tipover:



- Do not allow children to stand, climb or hang on furniture. It may topple and cause serious injury or death.

- Do not place toys or other child appealing items on top of this furniture, and place heaviest items towards the bottom of the furniture.

- Do not open more than one drawer at the time.



- Anchoring this product to a wall or other suitable surface is recommended. Check anchors regularly.

- Avoid putting a TV on this product.

Wall attachment guide

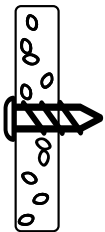

For plasterboard
(without available wood stud)

Securing method:
Self drilling plasterboard anchor.

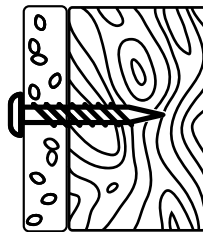

For plasterboard
(with available wood stud)

Securing method:
Screw inserted directly into stud.

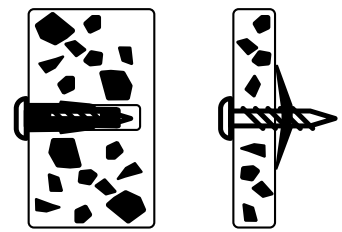

For masonry wall

Securing method:
Solid wall: Plug with screw
Hollow wall: Spring toggle

Please seek professional advice if you are in doubt of what fixing device to use.

Looks like you've found your Fantastic!

We're thrilled you've chosen Fantastic Furniture
to help create a home you'll love!



Fantastic Furniture

Love it? Share it!

Fantastic buy! Share how it looks at home on Instagram for
your chance to win a \$250 Fantastic Furniture Gift Card!

@fantasticfurniture

Assembly Checklist



Read through the instructions carefully before you begin.

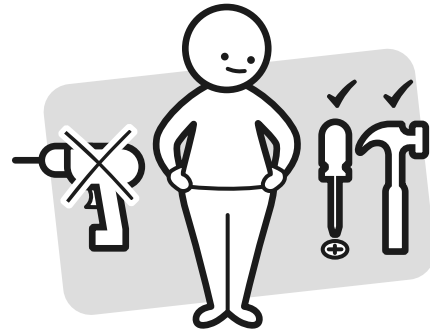

Make sure you have all the required tools. Never use power tools unless instructed.

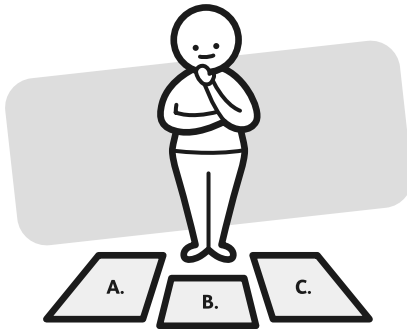

Identify and lay out all of the components before you begin assembly.

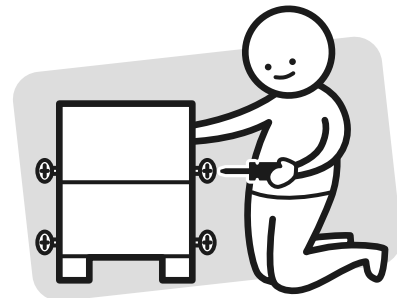

Unless instructed, do not fully tighten screws until the item is fully assembled.

Useful Information

- ! Never use power tools unless specifically instructed. They can damage your components or hardware if used incorrectly.
- ! The most common mistakes made during assembly are using the wrong hardware or getting components back to front.
- ! Always use a soft surface (such as carpet or cardboard) when assembling your product to avoid scratching or damaging the surface of the product.
- ! Bulky items such as wardrobes and bunk beds should be assembled in the room they will be used in as they may not fit through a door once assembled.
- ! Never use any glue until you are certain that the parts belong together.
- ! Periodically check and re-tighten all fasteners. Check the product care label or website for product care instructions.
- ! If you are having any difficulties assembling your product, missing any hardware or components please visit our website Help Centre for further assistance.
- ! Please see page 2 for any safety requirements or weight restrictions.

What you need

to assemble the product



DO NOT USE



Other tools you need:
Phillips Head Screwdriver;
Hammer

Side Panel
(P2)

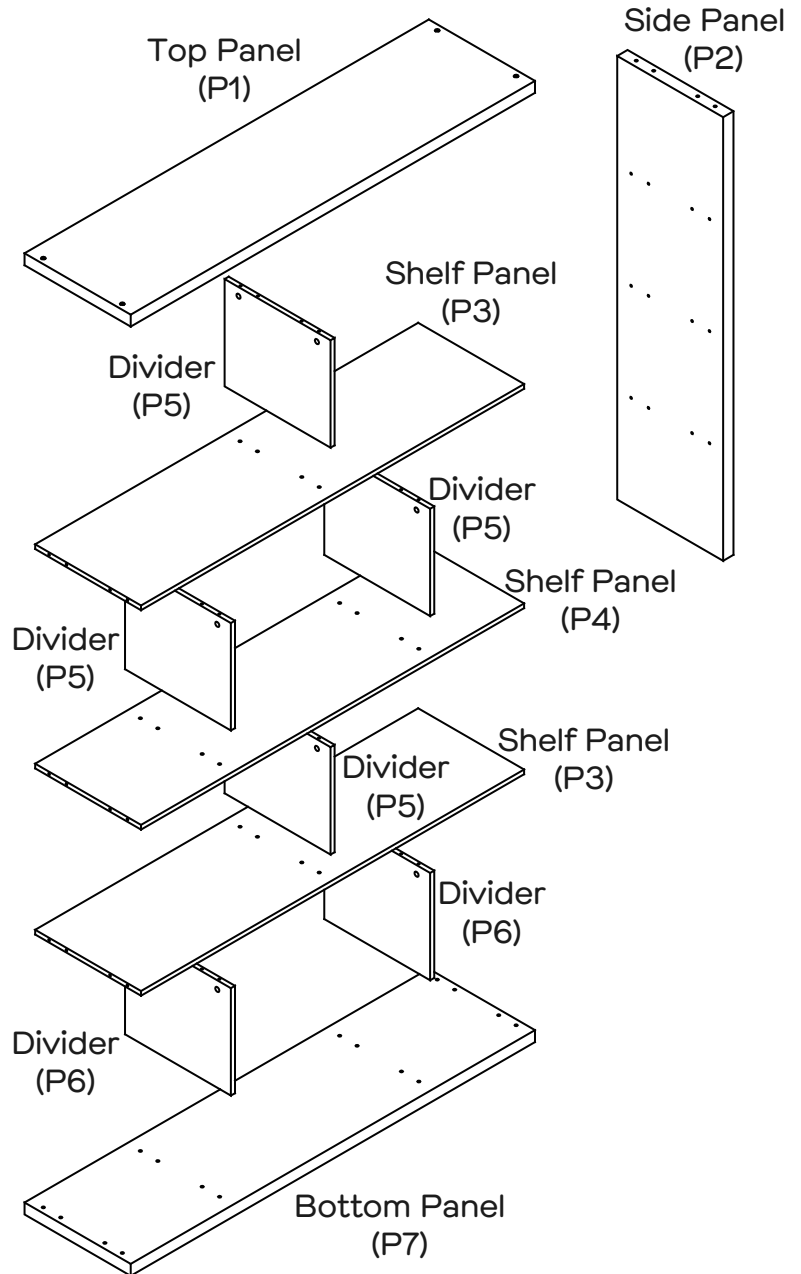



Parts list

Top Panel (P1);
2 x Side Panels (P2);
2 x Shelf Panels (P3);
Shelf Panel (P4);
4 x Dividers (P5);
2 x Dividers (P6);
Bottom Panel (P7);

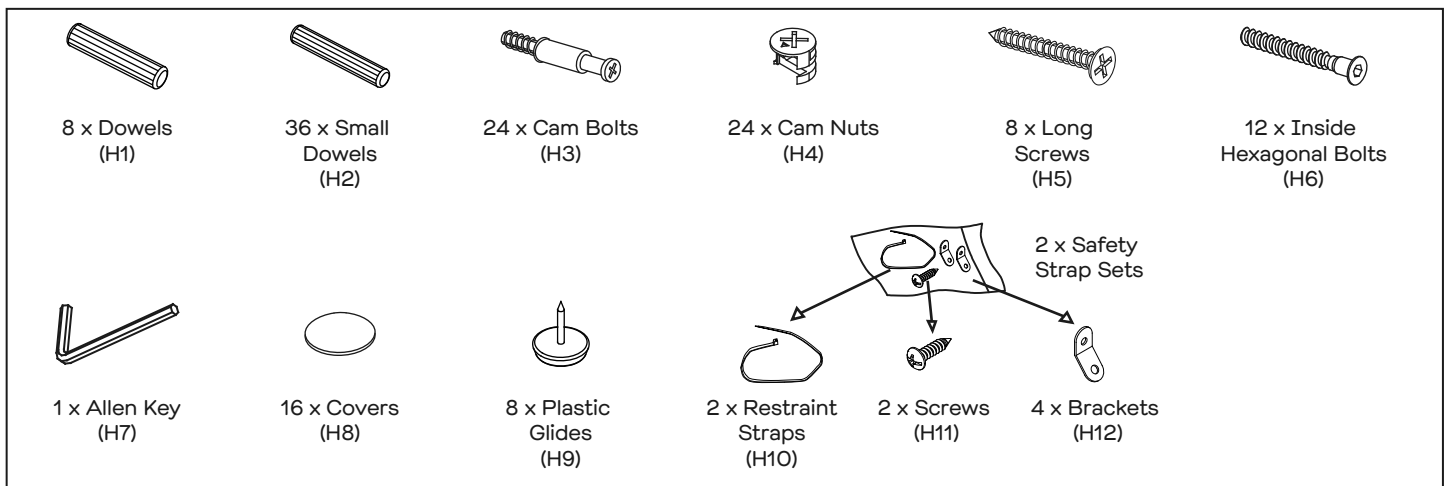
Hardware pack



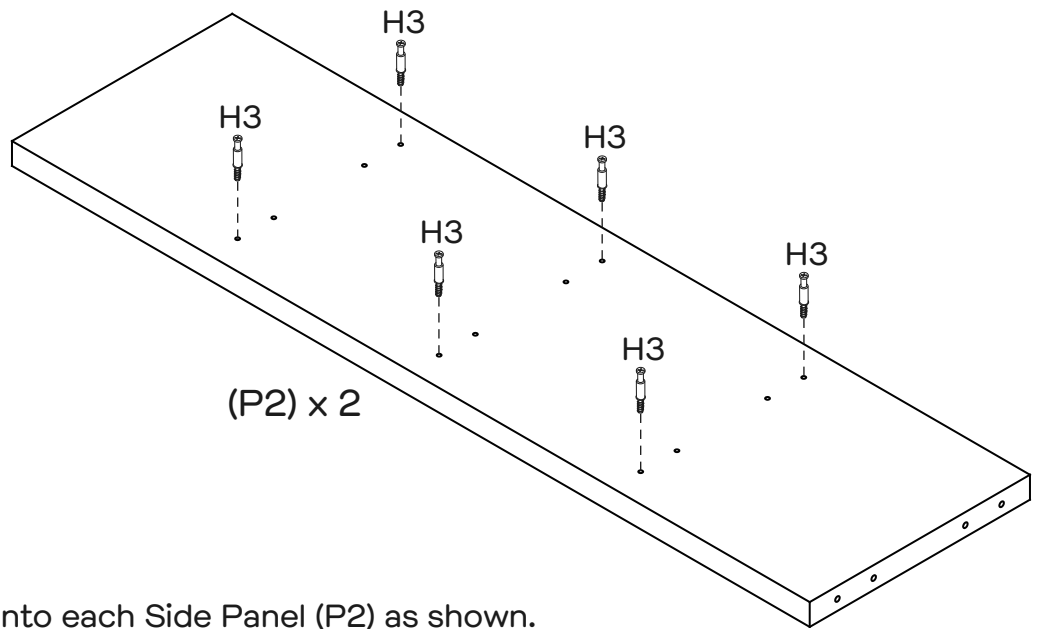

Step 1

You will need	
	
12 x Cam Bolts (H3)	Phillips Head Screwdriver



Attach 6 x Cam Bolts (H3) into each Side Panel (P2) as shown.

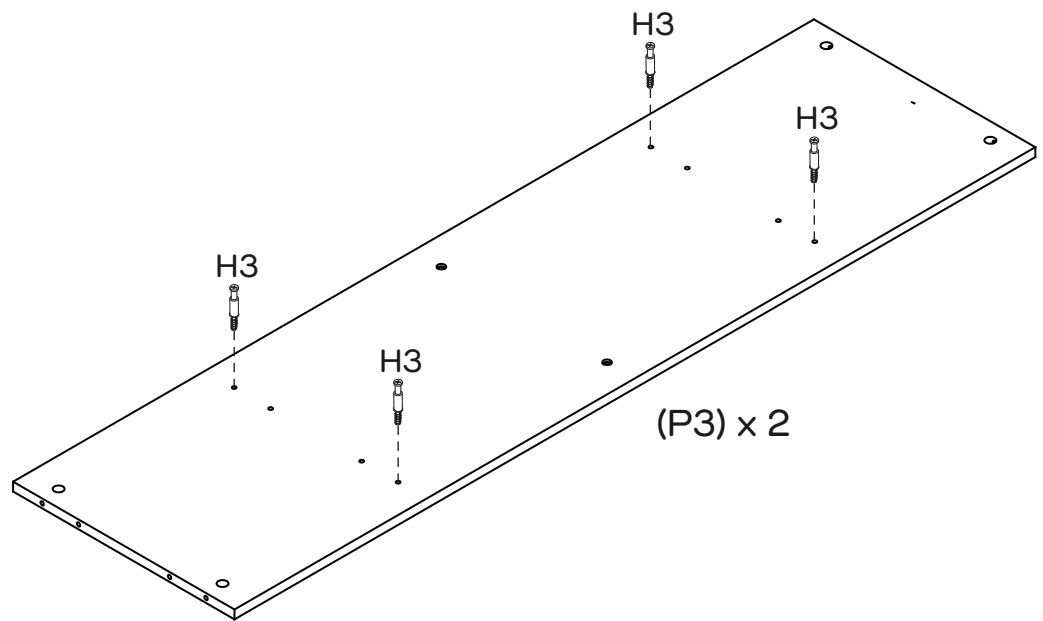

Step 2

You will need	
	
8 x Cam Bolts (H3)	Phillips Head Screwdriver



Attach 4 x Cam Bolts (H3) into each Shelf Panel (P3) as shown.

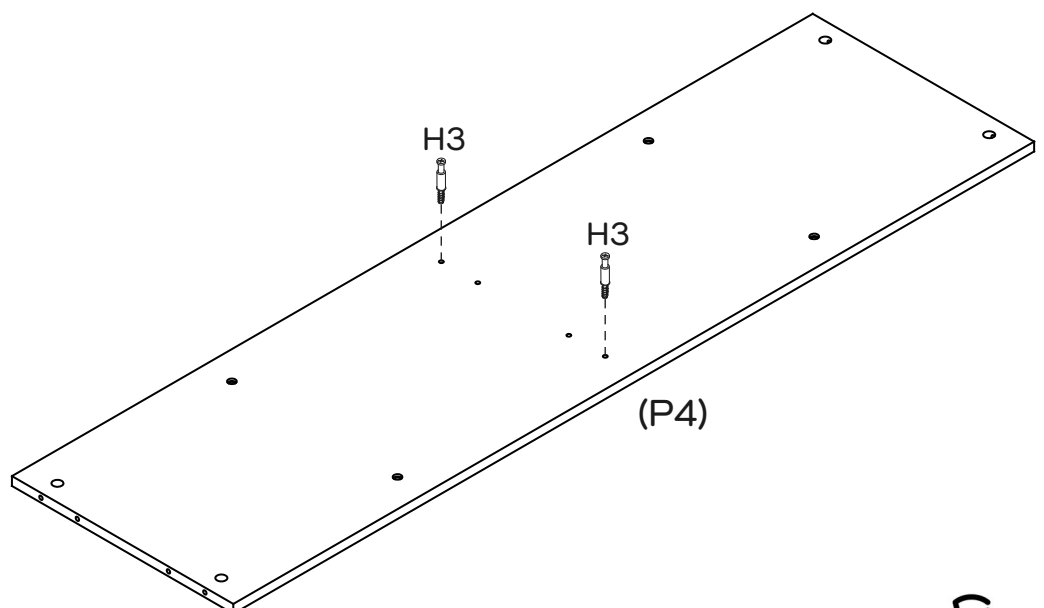

Step 3

You will need	
	
2 x Cam Bolts (H3)	Phillips Head Screwdriver



Attach 2 x Cam Bolts (H3) into Shelf Panel (P4) as shown.

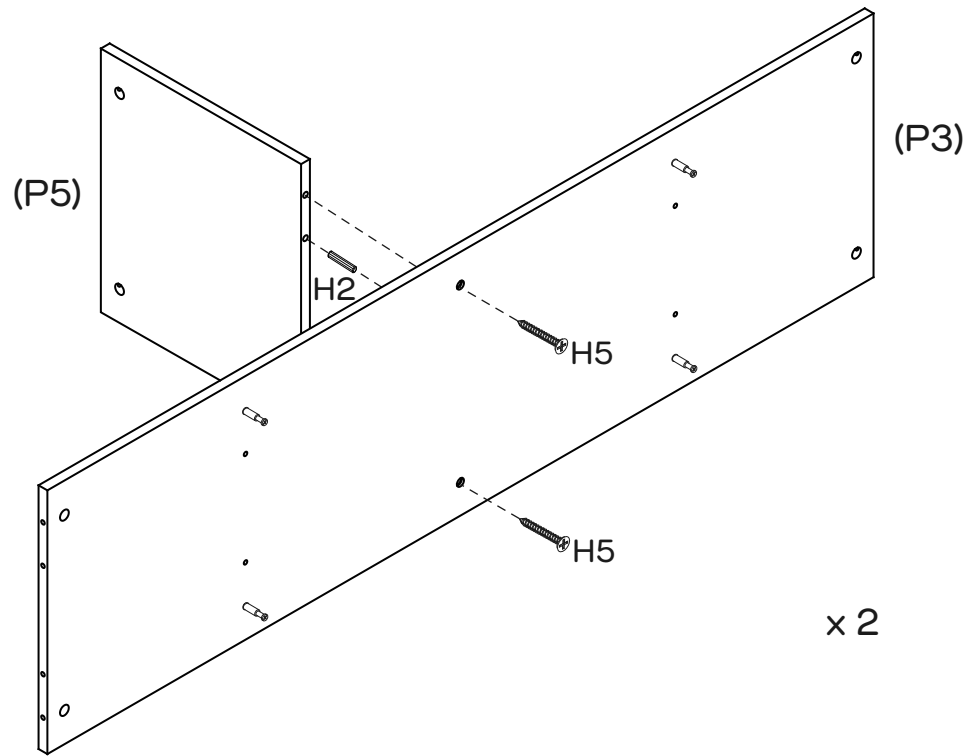

Step 4

You will need	
	
4 x Small Dowels (H2)	4 x Long Screws (H5)
	
Phillips Head Screwdriver	



Insert 2 x Small Dowels (H2) into the holes of Divider (P5) as shown.
 Attach Shelf Panel (P3) to Divider (P5) with 2 x Long Screws (H5).
 Tighten the screws with a Phillips Head Screwdriver.
 Repeat Step 4 for the other Divider (P5) and Shelf Panel (P3).



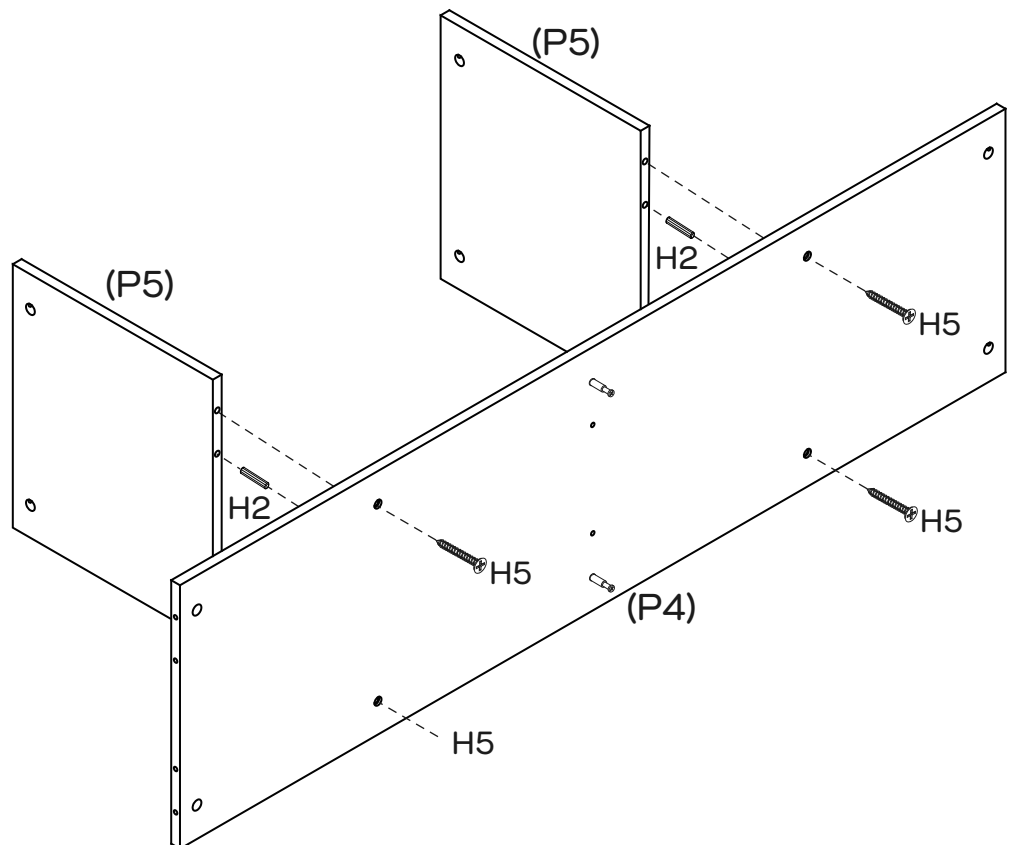

Step 5

You will need	
	
4 x Small Dowels (H2)	4 x Long Screws (H5)
	
Phillips Head Screwdriver	



Insert 4 x Small Dowels (H2) into the holes of Shelf Panel (P4) as shown.
 Attach Dividers (P5) to Shelf Panel (P4) with 4 x Long Screws (H5).
 Tighten the screws with a Phillips Head Screwdriver.

Step 6

You will need	
	
10 x Small Dowels (H2)	10 x Cam Nuts (H4)
	
10 x Covers (H8)	Phillips Head Screwdriver

This is how a cam nut works.....

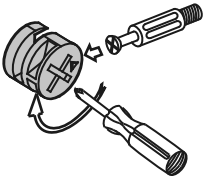

The head of the cam bolt goes into the open mouth of the cam nut. You then turn the cam nut so the arrows point towards the incoming Cam Bolts.

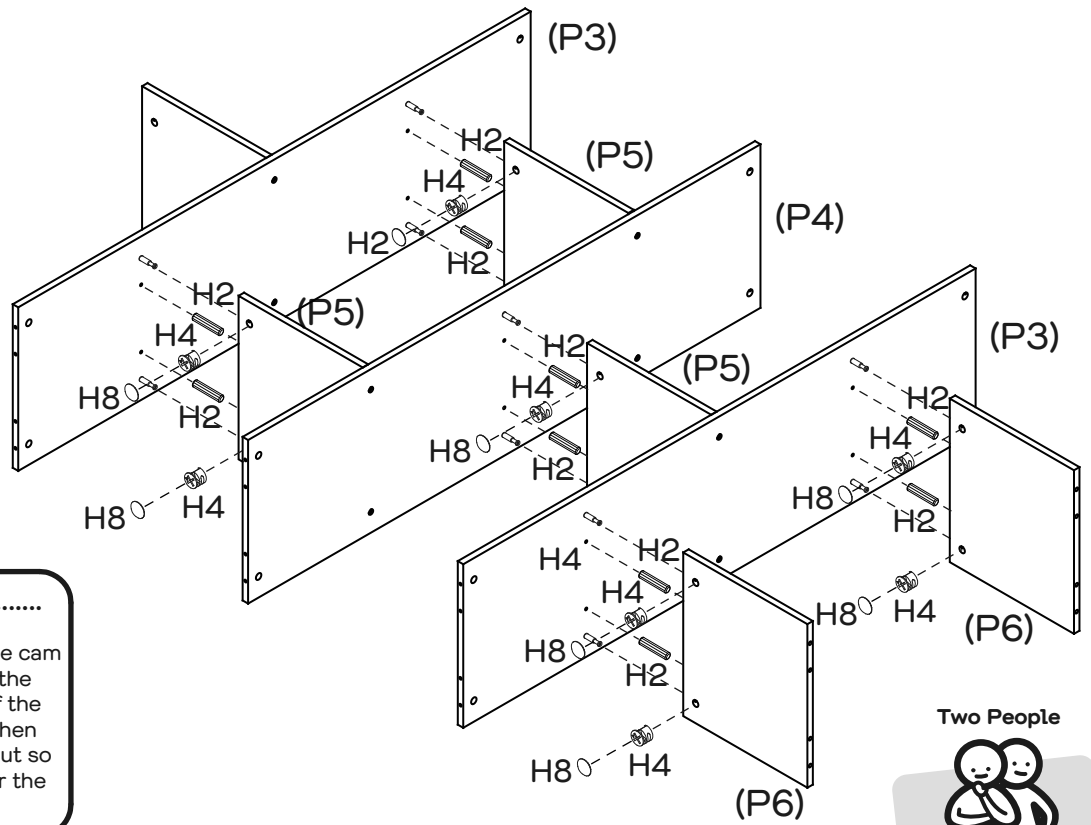

Two People



Required

Insert 10 x Small Dowels (H2) into the holes of Shelf Panels (P3, P4).



Insert 10 x Cam Nuts (H4) into the holes of Dividers (P5, P6).

Rotate the Cam Nuts so the arrows point towards the incoming Cam Bolts.

Push Dividers (P5, P6) into place and then tighten the Cam Nuts using a Phillips Head Screwdriver.

Seal the holes with 10 x Covers (H8) as shown.

Step 7

You will need	
	
6 x Small Dowels (H2)	6 x Cam Nuts (H4)
	
Phillips Head Screwdriver	

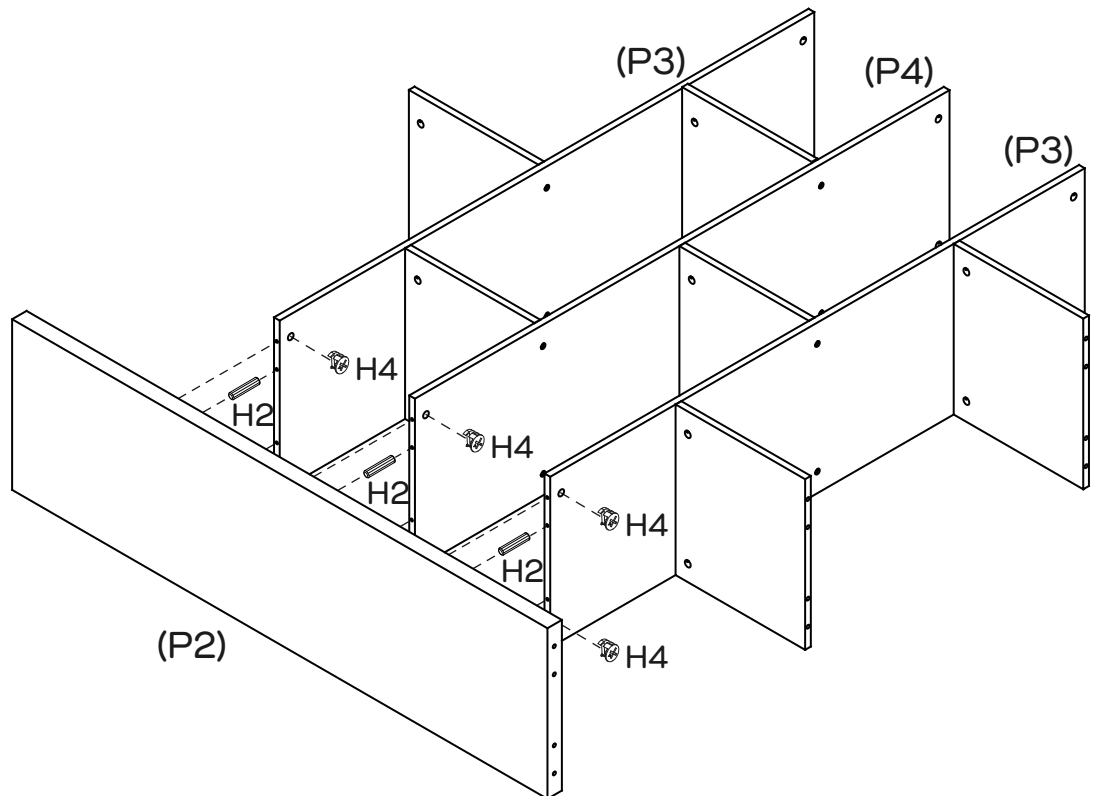

Insert 6 x Small Dowels (H2) into the holes of Shelf Panels (P3, P4).



Insert 6 x Cam Nuts (H4) into the holes of Shelf Panels (P3, P4).

Rotate the Cam Nuts so the arrows point towards the incoming Cam Bolts.

Push Side Panel (P2) into place and then tighten the Cam Nuts.

fantasticfurniture.com.au

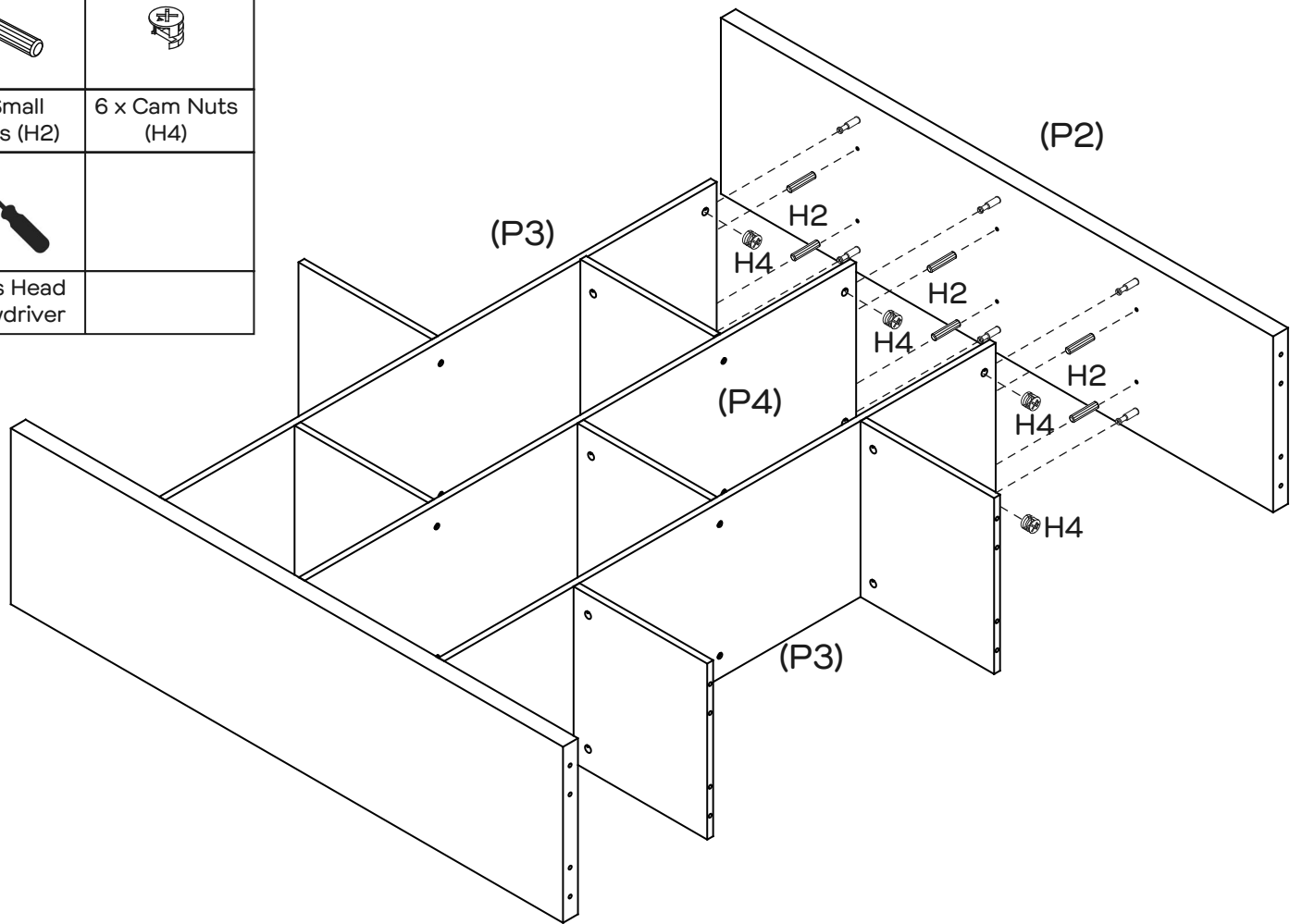

Step 8

You will need	
	
6 x Small Dowels (H2)	6 x Cam Nuts (H4)
	
Phillips Head Screwdriver	



Insert 6 x Small Dowels (H2) into the holes of Shelf Panels (P3, P4).
 Insert 6 x Cam Nuts (H4) into the holes of Shelf Panels (P3, P4).
 Rotate the Cam Nuts so the arrows point towards the incoming Cam Bolts.
 Push Side Panel (P2) into place and then tighten the Cam Nuts.



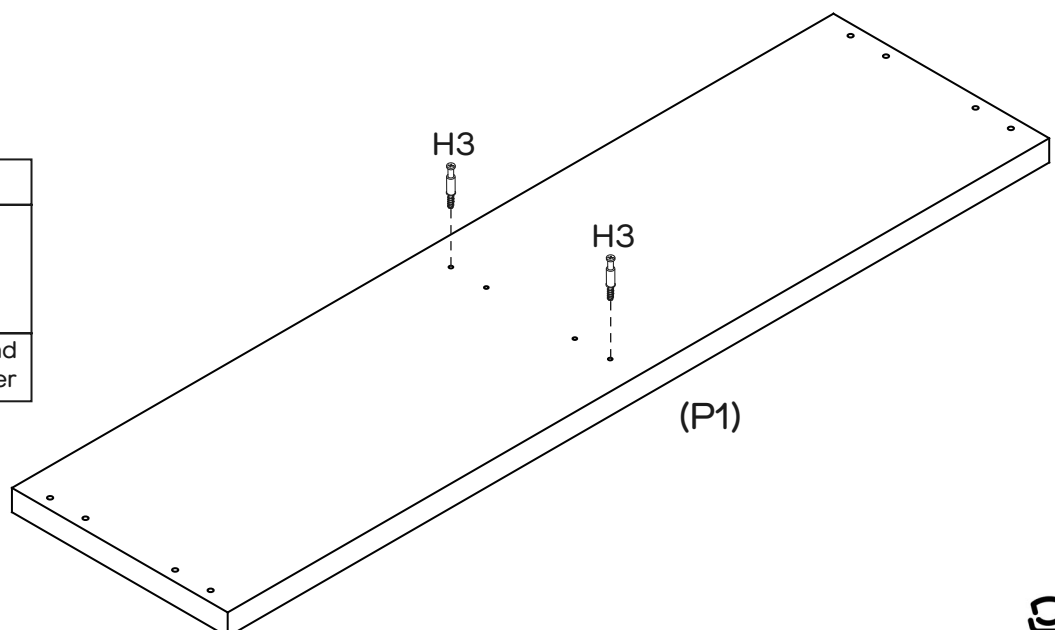

Step 9

You will need	
	
2 x Cam Bolts (H3)	Phillips Head Screwdriver

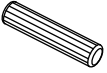
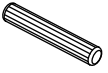

Attach 2 x Cam Bolts (H3) into Top Panel (P1) as shown.

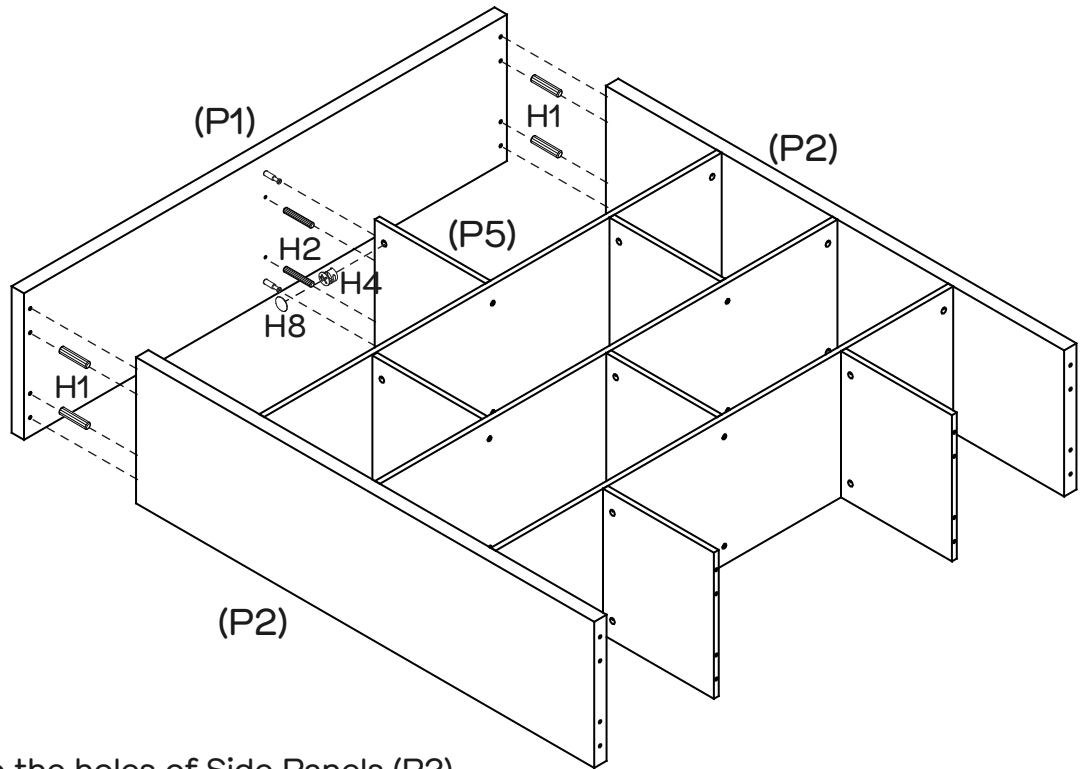

Step 10

You will need	
	
4 x Dowels (H1)	2 x Small Dowels (H2)
	
2 x Cam Nuts (H4)	2 x Covers (H8)
	
Phillips Head Screwdriver	



Insert 4 x Dowels (H1) into the holes of Side Panels (P2).
 Insert 2 x Small Dowels (H2) into the holes of Divider (P5).
 Insert 2 x Cam Nuts (H4) into the holes of Divider (P5).
 Rotate the Cam Nuts so the arrows point towards the incoming Cam Bolts.
 Attach Top Panel (P1) to Side Panels (P2) and Divider (P5).
 Tighten the Cam Nuts using a Phillips Head Screwdriver.
 Seal the holes with 2 x Covers (H8) as shown.

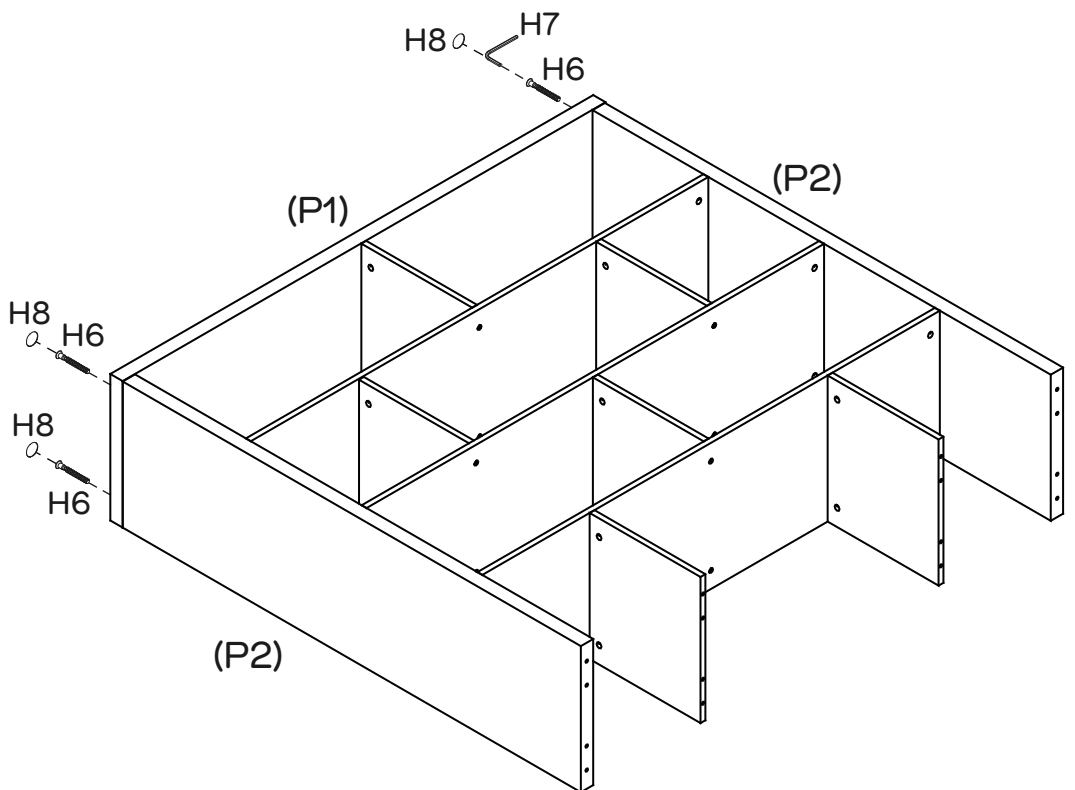

Step 11

You will need	
	
4 x Inside Hexagonal Bolts (H6)	1 x Allen Key (H7)
	
4 x Covers (H8)	



Secure Top Panel (P1) to Side Panels (P2) with 4 x Inside Hexagonal Bolts (H6) using an Allen Key (H7).
 Seal the holes with 4 x Covers (H8) as shown.

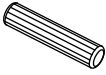
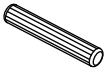

Step 12

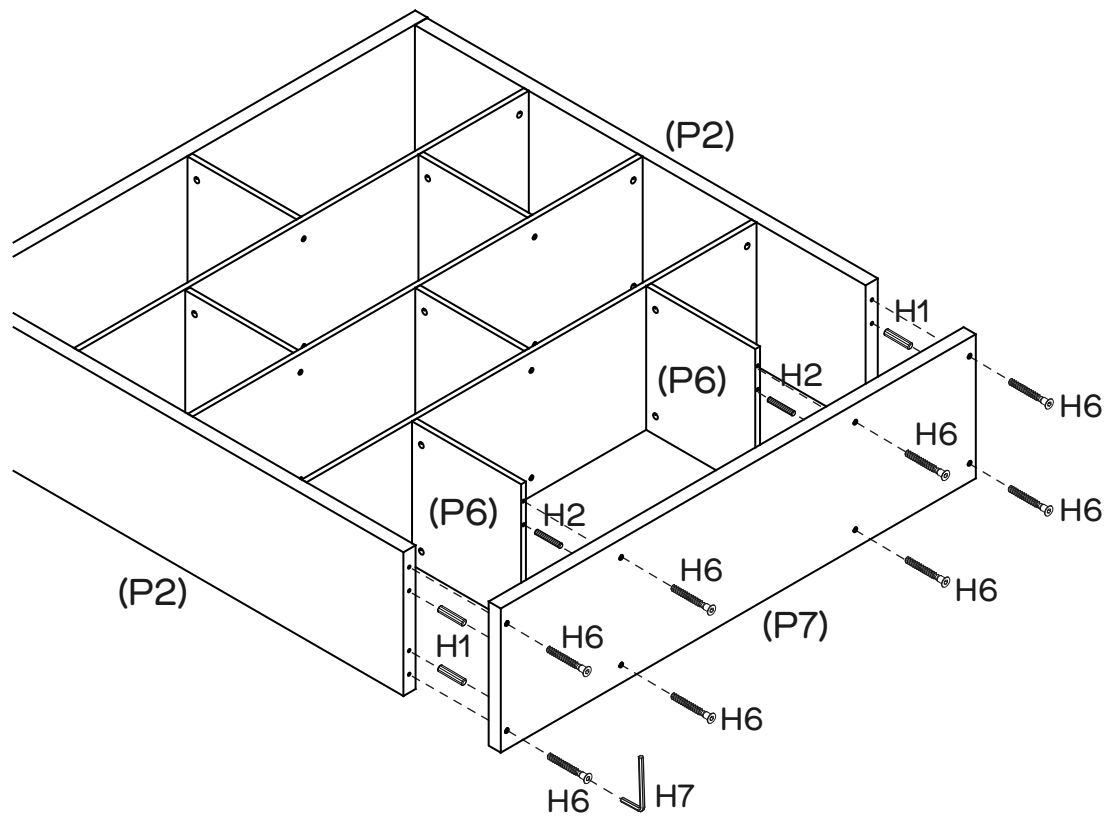
You will need	
	
4 x Dowels (H1)	4 x Small Dowels (H2)
	
8 x Inside Hexagonal Bolts (H6)	1 x Allen Key (H7)



Insert 4 x Dowels (H1) into the holes of Side Panels (P2).
 Insert 4 x Small Dowels (H2) into the holes of Dividers (P6).
 Attach Bottom Panel (P7) to Side Panels (P2) and Dividers (P6) with 8 x Inside Hexagonal Bolts (H6) using an Allen Key (H7).

Step 13

You will need	
	
8 x Plastic Glides (H9)	Hammer

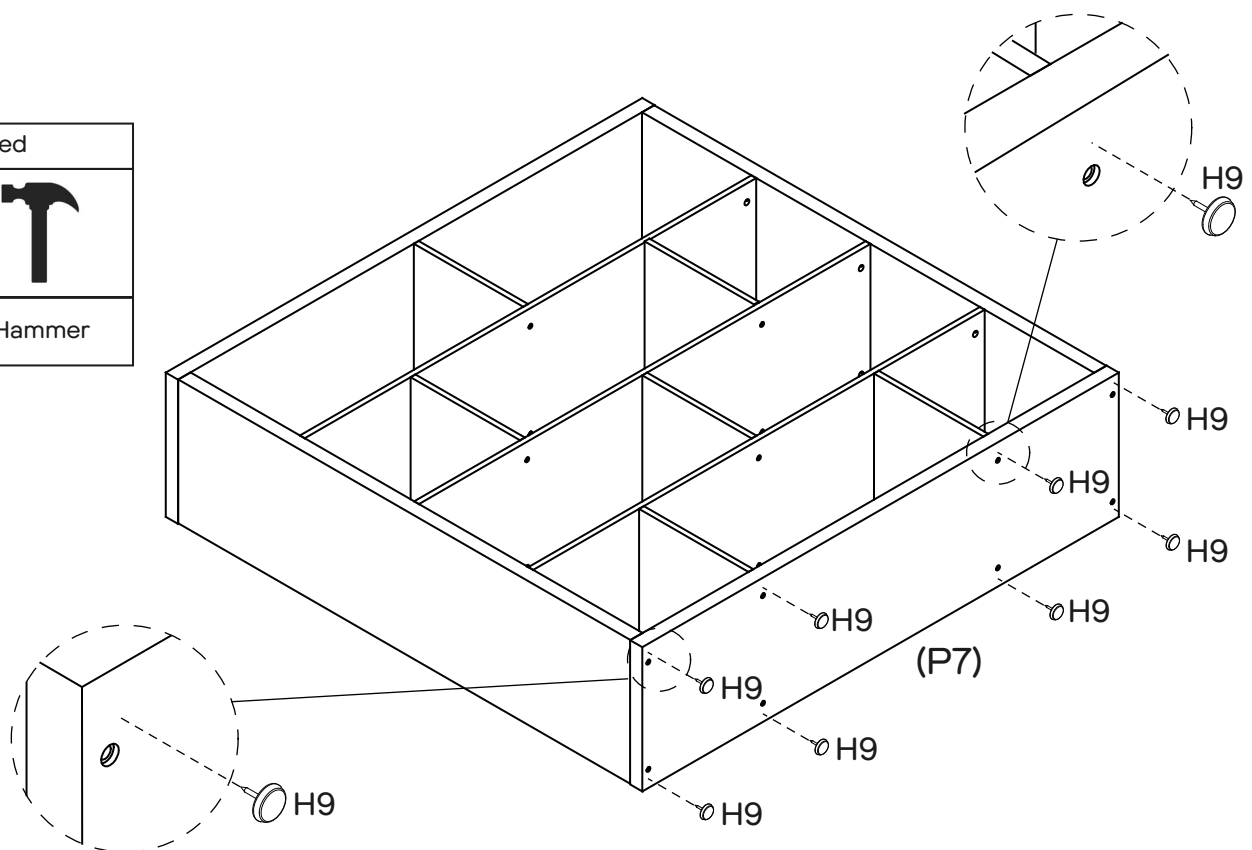





Place glides 10mm from edge.

Attach 8 x Plastic Glides (H9) to the bottom of Bottom Panel (P7) with a Hammer.

Step 14

We strongly advise that you use the wall safety strap provided to prevent the unit toppling

Seek advice from a qualified trades person on how to attach this safety strap to your specific wall.

You will need	
	
2 x Restraint Straps (H10)	2 x Screws (H11)
	
4 x Brackets (H12)	Phillips Head Screwdriver
Screw and Wall Plug are not provided. Please use appropriate fixtures for your wall.	

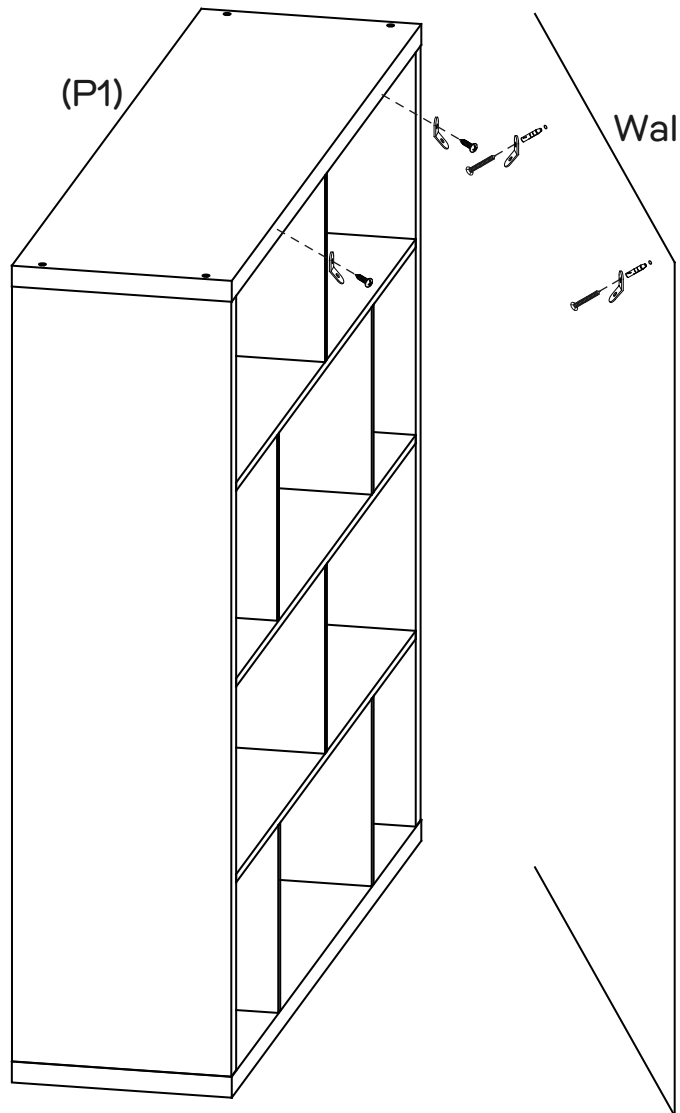
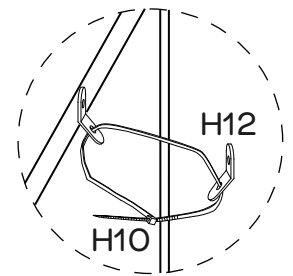
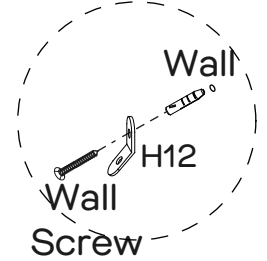
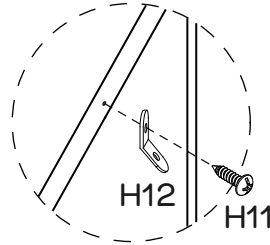

Two People



Required

Carefully turn the bookcase over to an upright position.

Attach 2 x Brackets (H12) securely to back of Top panel (P1) with 2 x Screws (H11) through the smaller hole.

Align the opposite wall Bracket about 20mm lower than the one attached to the bookcase so the Bracket can't be seen.

Using appropriate wall connection fixtures, secure the Bracket to the wall and thread the Restraint Strap through it.

Be careful not to over tighten the strap which would cause the unit to lean.

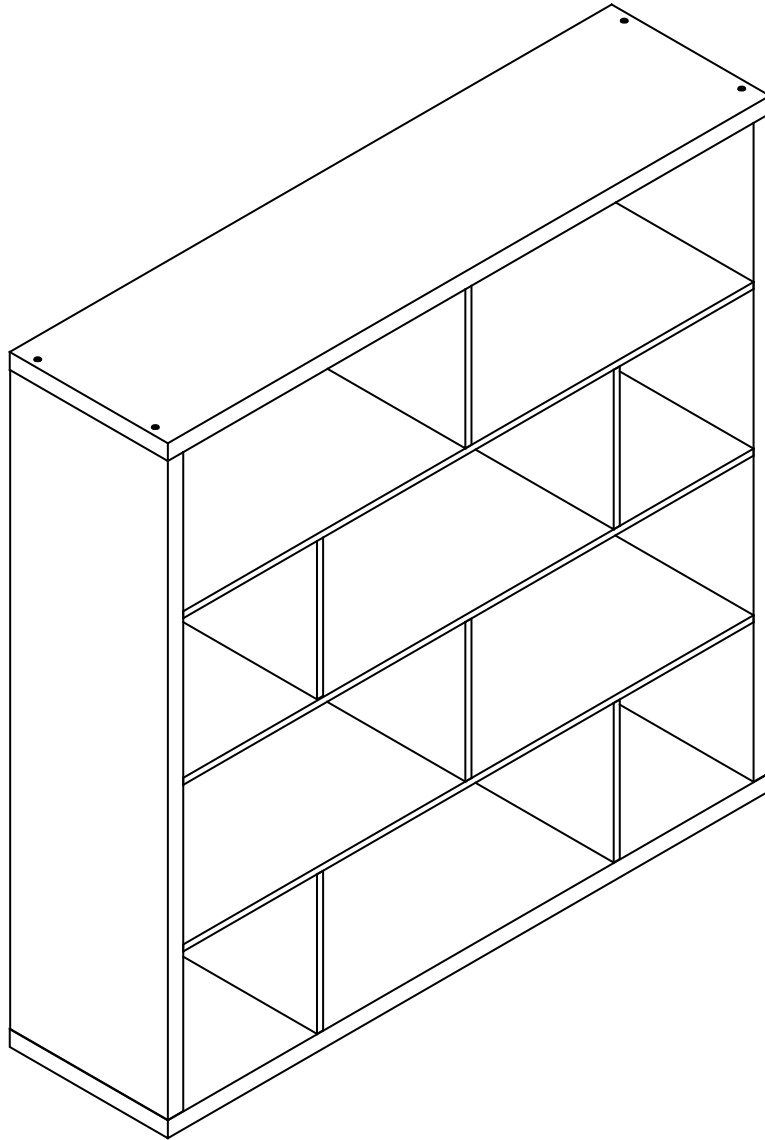

Job Complete!

In the interest of our environment please dispose of all packaging thoughtfully.