

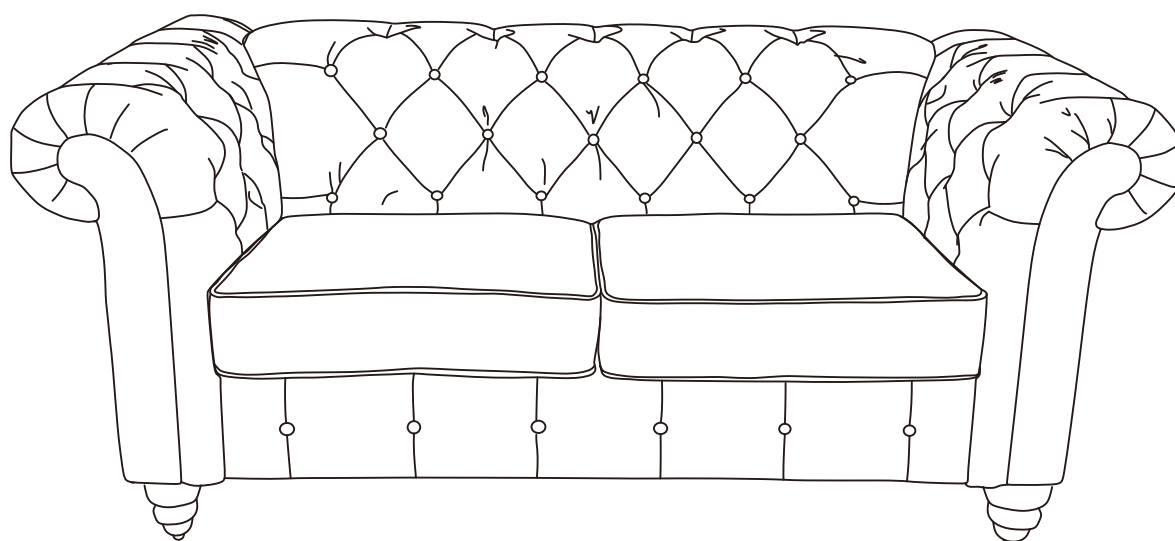

**Fantastic
Furniture**

Version 1.0



TWO PEOPLE

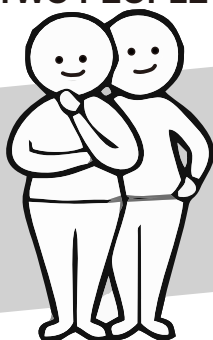

REQUIRED

Carlotta

Sofa 2 STR

www.fantasticfurniture.com.au

Looks like you've found your Fantastic!

we're thrilled you've chosen Fantastic Furniture
to help create a home you'll love!



Fantastic Furniture

Love it? Share it!

Fantastic buy! Share how it looks at home on Instagram for
your chance to win a \$250 Fantastic Furniture Gift Card!

@fantasticfurniture

Assembly checklist



Read through the instructions carefully before you begin.

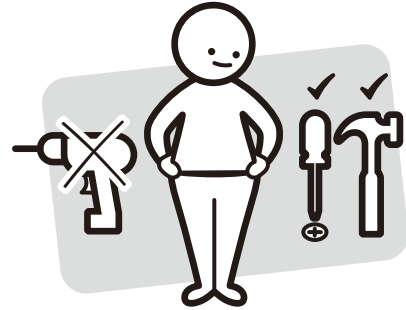

Make sure you have all the required tools. Never use power tools unless instructed.

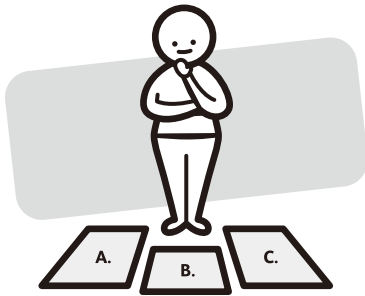

Identify and lay out all of the components before you begin assembly.

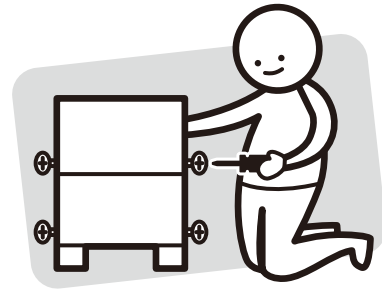

Unless instructed, do not fully tighten screws until the item is fully assembled.

Useful information

- ! Never use power tools unless specifically instructed. They can damage your components or hardware if used incorrectly.
- ! The most common mistakes made during assembly are using the wrong hardware or getting components back to front.
- ! Always use a soft surface (such as carpet or cardboard) when assembling your product to avoid scratching or damaging the surface of the product.
- ! Bulky items such as wardrobes and bunk beds should be assembled in the room they will be used in as they may not fit through a door once assembled.
- ! Never use any glue until you are certain that the parts belong together.
- ! Periodically check and re-tighten all fasteners. Check the product care label or website for product care instructions.
- ! If you are having any difficulties assembling your product, missing any hardware or components please visit our website Help Centre for further assistance.
- ! Please see page 2 for any safety requirements or weight restrictions.

What you need

to assemble the product



DO NOT USE

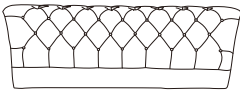

1x Back Rest (P1)

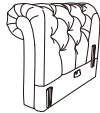

1x Left Arm (P2)



1x Right Arm (P3)

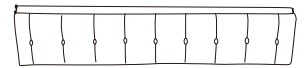

1x Sofa Front Panel (P4)



1x Sofa Base Panel (P5)



2x Cushions (P6)



4x Legs (P7)

Step 1

TWO PEOPLE

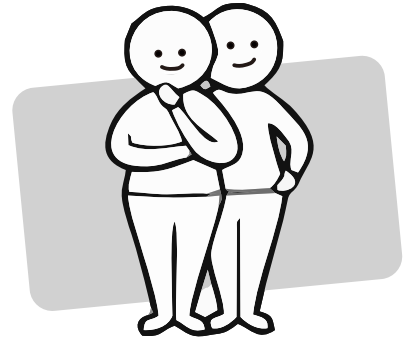

REQUIRED

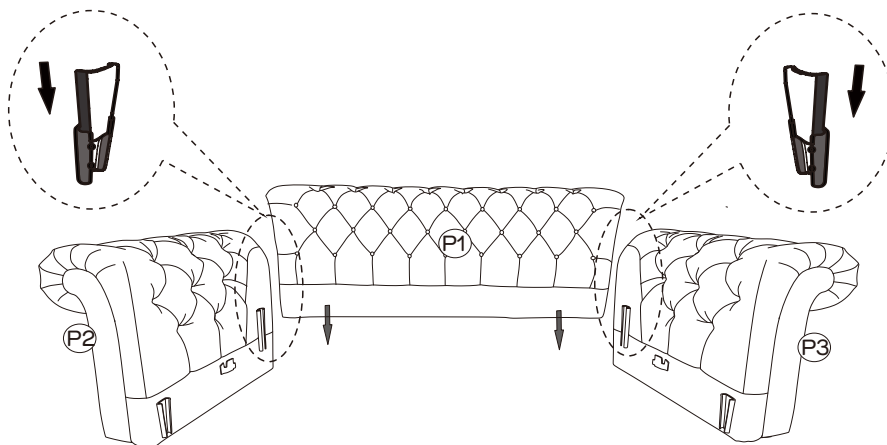

Align the brackets on the sofa back rest (P1) to the sofa arms (P2 & P3). Slot the back rest (P1) into the brackets of the sofa arms (P2 & P3). Do this one arm at a time. Ensure the brackets are slotted in fully.

Step 2

TWO PEOPLE

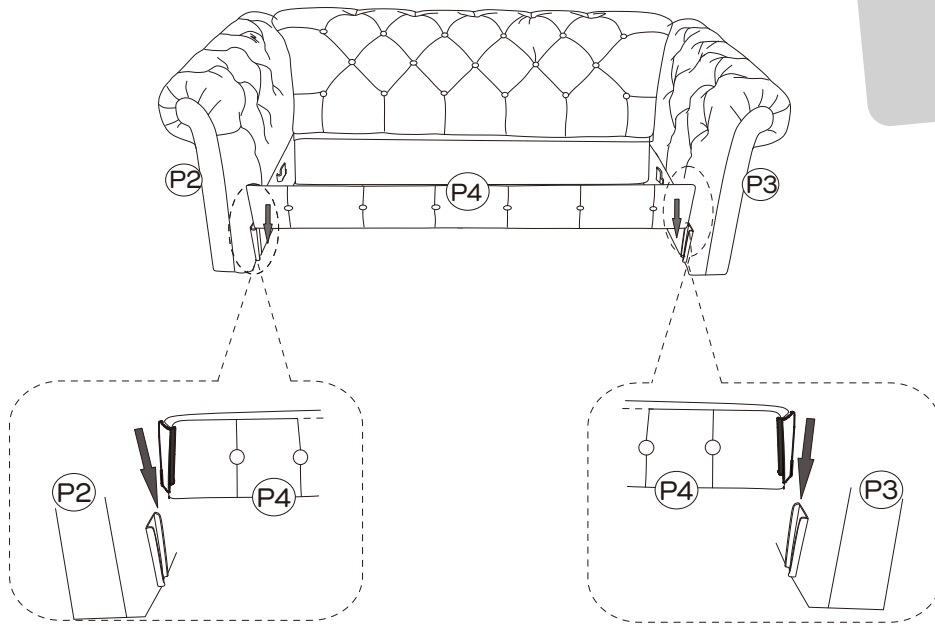
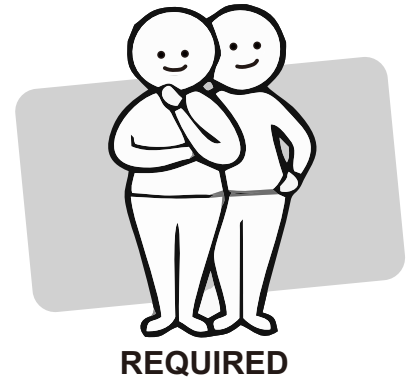

Align the brackets of the sofa front panel (P4) to the brackets on the sofa arms (P2 & P3). Slot the sofa front panel (P4) into the brackets of the sofa arms (P2 & P3). Ensure the brackets are slotted in fully.

Step 3

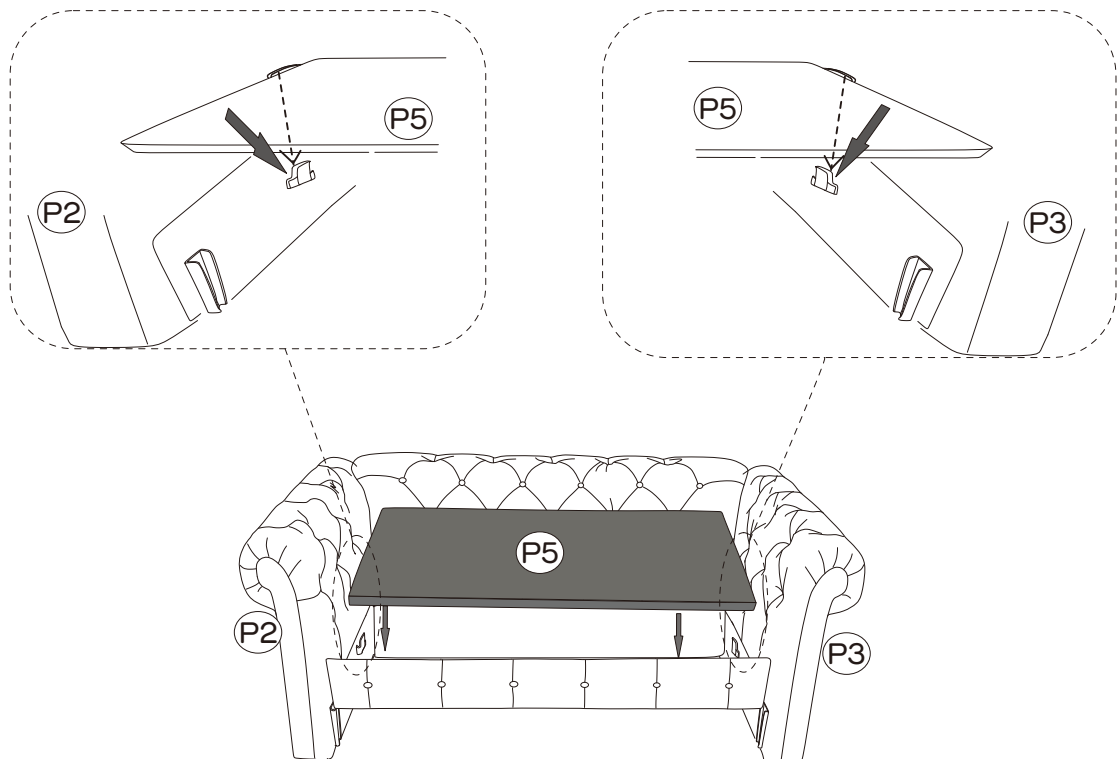

Align the brackets of the sofa base panel (P5) with the brackets on the sofa arms (P2 & P3). Slot the brackets of the base panel (P5) into the brackets of the sofa arms (P2 & P3). Ensure the brackets are slotted in fully.

Step 4

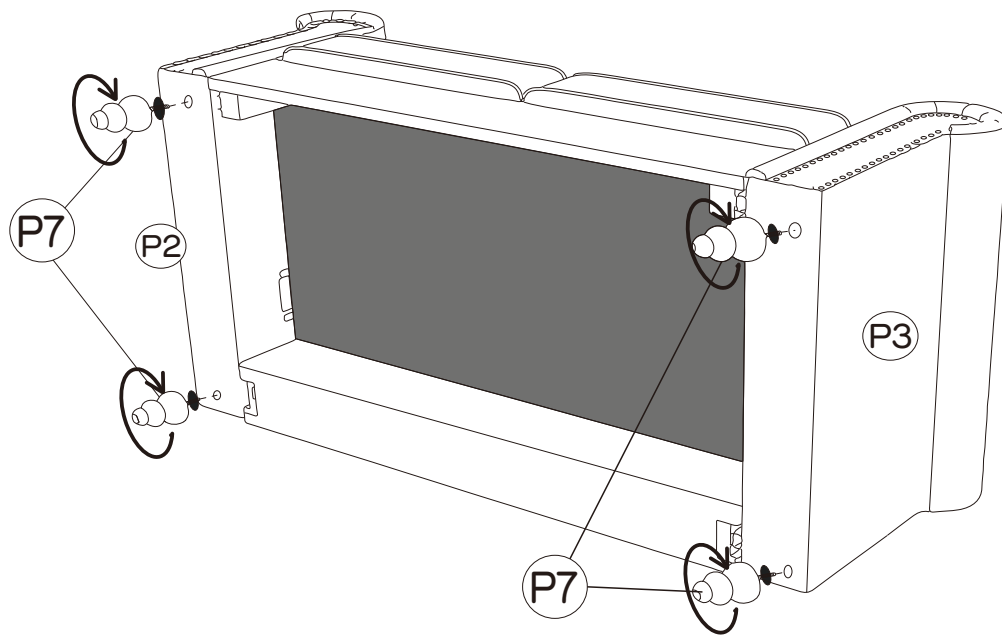

Flip the sofa on to its back and attach 4 x legs (P7) as shown to the underside of the sofa.

Step 5

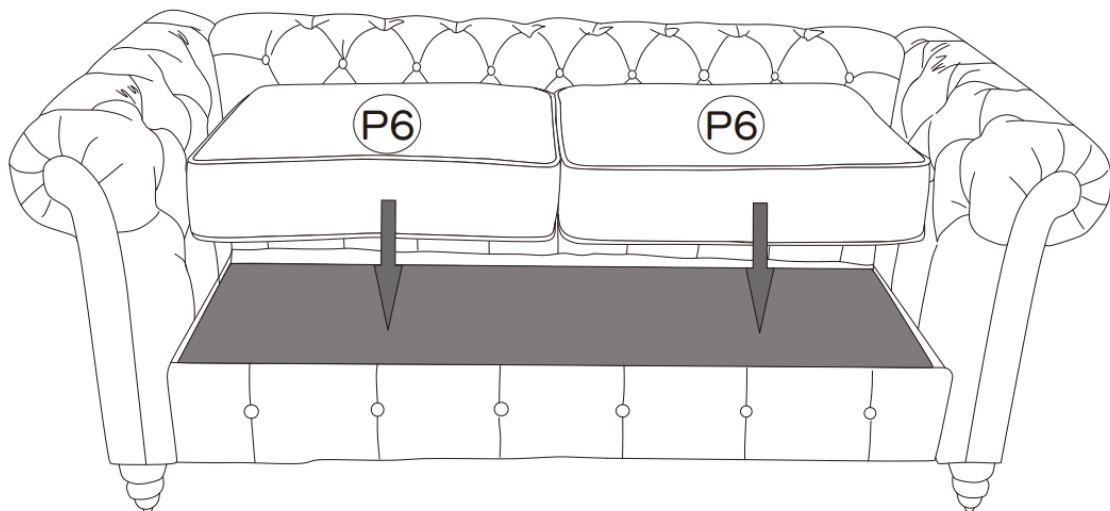

Place cushions (P6) on the sofa base as shown.

Step 6

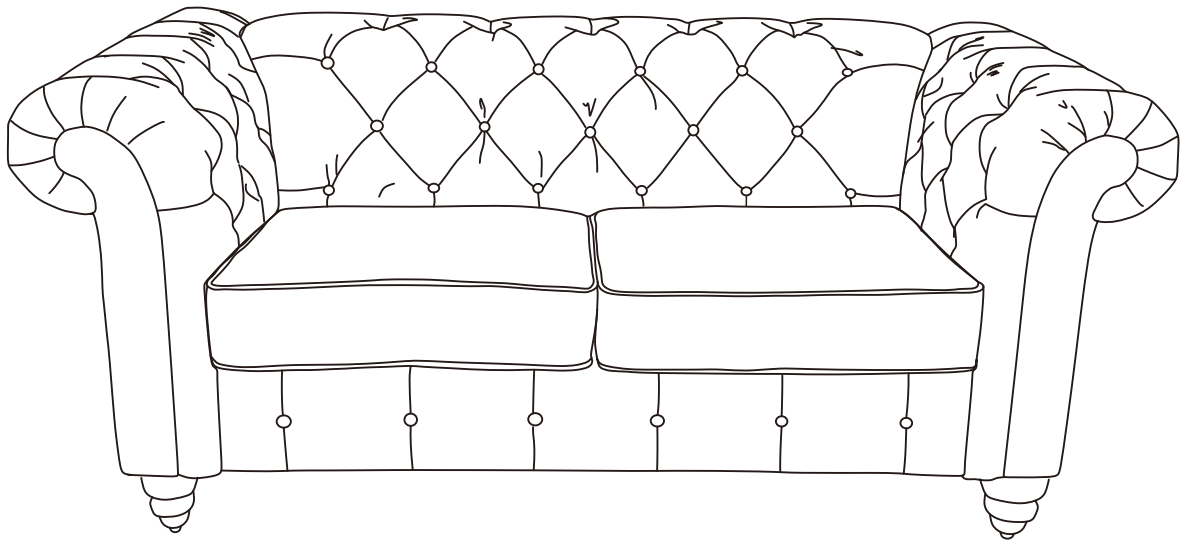

Job Complete

In the interest of our environment please dispose
of all packaging thoughtfully.